



Sentry 2.0

Digital Temperature Controller

Complete Operating Instructions

See pages 28-29 for instructions on upgrading your DTC 100, 600, 800 or 1000 series board to the Sentry.

Cone-Fire (pg 8-11)

From IdLE, press 1.
Available only on ceramic kilns. Fires to a pyrometric cone. Enter cone, speed, pre-heat, hold, and slow cool.

Ramp-Hold (pg 12-15)

From IdLE, press 4.
Select stored program (1 - 4). Enter rate, temperature, and hold for each segment.

Alarm (pg 6)

From IdLE or during firing, press 7.
Enter a temperature. When alarm sounds during firing, press Enter.

Enter/Start (pg 7)

Press Enter/Start after each step in programming a firing. Press Enter/Start once to begin the firing.

Options (pg 17 - 21)

From IdLE, press 0. Press Enter for option displayed.

Cone-Fire Options

SPd Speed Change the speed of a Cone-Fire program beyond the Fast, Medium, or Slow.

OFST Cone Offset Adjust controller to a witness cone.

FAN Vent Fan Selects when the vent fan will operate. (Special option not on all kilns.)

Standard Options

TCOS Thermocouple Offset Calibrate the thermocouple temperature.

CHG- Select °F or °C.

TC Thermocouple Type Select Type K, S or R.

AOP AOP Outlet Select vent fan or alarm. This is a special option not on all kilns.



Delay (pg 6)

From IdLE, press 3.
Enter time in hours:minutes. Delays the start of firing.

Add Time (pg 6)

During firing, press 2.
Each additional key press adds five minutes to a hold. It works in both Ramp-Hold and Cone-Fire.

Present Status (pg 6)

Press 5 during firing.
Shows the segment that is currently firing. Works in both Ramp-Hold and Cone-Fire.

Program Review (pg 6)

From IdLE or during firing, press 6.
Shows the program that is loaded in memory and ready to fire, or the one that is firing.

Id Computer ID Select identification number for output to a computer.

TEdE Temperature Deviation Set temperature sensitivity of error codes.

SFTY Maximum temp.

ELEC Electronics Temp. Check board for overheating.

LOCK Program Lock Make a program tamper-proof.

CFG Configuration Code For technicians.

SOFT Software Version For technicians.

TEST Element Test Diagnostics tool for checking elements.

RST Reset Removes cone and thermocouple offsets, etc.

Stop/Back (pg 7)

Press during firing or programming.

Stops a firing. In Options, takes you back to IdLE. During programming, takes you back one step each time key is pressed.

Multiple Zone Options

DIFF Difference Largest temperature difference between any two zones.

CAdJ Center Adjustment Change center heat of some two-zone kilns.

T123 Zone Temperatures Shows temperature of each zone.

Introduction



Thank you for purchasing the Sentry micro processor, our most advanced generation of digital temperature controllers. The easiest way to learn to operate the Sentry is to sit down in front of it with these instructions and play with it. Spend time understanding the controller before you begin to use it.

Damage caused by failure to follow instructions is not covered by warranty.

The Sentry operates in Cone-Fire and Ramp-Hold similar to the earlier DTC 600, 800, and 1000 series. If you are familiar with the earlier controllers, you can follow many of the same operating procedures with the Sentry.

The Cone-Fire mode applies to ceramics only. If you purchased a heat treating, glass fusing, enameling or jewelry furnace, your version of the Sentry will include only the Ramp-Hold mode, not the Cone-Fire. In this case, please disregard “FAST,” “MEDIUM,” “SLOW,” “Cone Fire” and “Cone #s” on your keypad.

If you purchased the TnF 2 portable controller, you should find a TnF 2 installation instruction sheet in addition to these instructions.

Instructions for multiple-zone kilns are included in this manual. If you are not sure whether your kiln is multiple-zone, look into the firing chamber. If you see two or three thermocouple tips, your kiln is multiple-zone. If you see only one thermocouple, skip multiple-zone instructions.

Do not worry if you hear a distinct clicking noise during operation. Mechanical relays click as they turn the heating elements on and off.

You can connect your Sentry controller to a personal computer, which will allow you to graph your firings and to monitor them from a distance. Ask for the computer interface kit, which consists of a cable, a computer chip for the back of the Sentry, and software for your computer.

Once you learn the basic features of the Sentry, you will be able to control every stage of firing. This offers learning opportunities and convenience difficult to imagine with a manual controlled kiln.



Contents

Basic Pointers 4

- Which Instructions
- Apply to Your Controller 4
- Room Temperature and Humidity... 4
- Thunder Storms and Power Surges . 4
- Display Lights 5
- How to Get IdLE to Display 5
- Firing Completion Message 5
- Repeat Firings 5
- Thermocouple Inspection 5
- The “LId” Display 5

The Keys 6

- Correcting Entries 6
- 1 / Cone Fire 6
- 2 / Add Time 6
- 3 / Delay 6
- 4 / Ramp Hold 6
- 5 / Present Status 6
- 6 / Program Review 6
- 7 / Alarm 6
- 9 / Cone Numbers & Skip Segment . 7
- Enter/Start 7
- The Options Key 7
- The Stop/Back Key 7

Cone-Fire 8

- Standard Schedules
- Low Fire Cones 022 - 011 9
- Middle Fire Cones 010 - 01 9
- High Fire Cones 1 - 10 9
- Speed (SPd) 9
- Pre-Heat (PRHT) 9
- Hold (HOLd) 10
- Cone-Fire Programming 10
- Slow Cooling (COOL) 11
- When the Kiln Shuts Off Too Soon . 11
- For Kilns with AOP Outlet 11

Ramp-Hold 12

- Definition of a Segment 12
- Ramp-Hold Programming 13
- User Programs (USER) 13
- Firing a Stored User Program 14
- Rate 14
- Hold (HOLd) 14
- AOP Fan 14
- Segments for Controlled Cooling . 14
- Sample Firing Schedules 14
- Cone-Fire Program Fired in Ramp-Hold 14
- Sculptured Stoneware Bisque Firing Schedule, Cone 04. 14
- Glass Fusing Firing Schedule ... 15

- Glass Slumping Firing Schedule . 15
- Starting a Firing in a Hot Kiln. 15
- When the Kiln Shuts Off Too Soon . 15

Multiple Zone Kilns 16

- An Overview of Multiple Zone Firing 16
- Viewing Zone Temperatures 16
- Two Zone Kilns: Adjust Heat in Center Section (CAAdJ) 16
- Thermocouple Failure In a Multiple Zone Kiln 16
- Power Output Lights 16
- Testing Multiple Zone Elements ... 16

Options: Cone-Fire 17

- Cone-Fire Speed (Spd) 17
- Cone Offset (OFST) 17
- Interpreting Cone Bending 18
- When Cone Temperature Is Off More Than 20°F/11°C 18
- Fan (FAN) 18

Options: General 18

- Thermocouple Offset (TCOS) 18
- Thermocouple Offset for Ceramic Firings 18
- Calibrating Thermocouple Offset With a Digital Pyrometer 19
- Setting Thermocouple Offset ... 19
- Multiple Zone Thermocouple Offset 19
- Selecting °F or °C (CHG-) 19
- °F/°C Temperature Conversion Formula 19
- Thermocouple Type (TC) 19
- AOP Outlet (AOP) 20
- Computer ID (ID) 20
- Temperature Deviation (TEDE) ... 20
- Maximum Temperature (SFTY) ... 20
- Electronics Temperture (ELEC).... 20
- Program Lock (LOCK) 20
- Configuration Code (CFG) 21
- Software Version (SOFT) 21
- Element Test (TEST) 21
- Reset (RST) 21

Options: Multiple Zone .. 21

- Zone Temperature Difference (DIFF) 21
- Two Zone Kilns: Adjust Heat in Center Section (CAAdJ) 21
- Zone Temperatures (T123) 21

Error Messages 22

- FTC / Failed to Cool 22
- FTH / Failed to Heat 22
- LTdE / Low Temperature Deviation 22
- PF / Power Failure 22
- BAdP / Bad Programming 22
- ETH / Electronics Too Hot 22
- FAIL / Thermocouple Failure 22
- FTL / Firing Too Long 22
- HTdE / High Temperature Deviation 22
- PF 2 / Power Failure 22
- PF 3 / Power Failure 22
- How the Sentry Handles Power Failures 23
- Using Ceramic Witness Cones After an Extended Power Failure . 23
- PLOG Error Codes 23
- TCdE / Uneven Multiple Zone Temperatures 23
- TCR / Thermocouple Leads Reversed 23

Appendix A

- Display Messages 24

Appendix B

- Standard Cone-Fire Schedules 26

Appendix C

- Upgrading the DTC 100, 600, 800 & 1000 to the Sentry 28

Appendix D

- Orton Pyrometric Cone Temperature Equivalents 30

Appendix E

- Ramp-Hold Shorthand 31

Appendix F

- Cone-Fire Shorthand 32

Safety

The warranty on your Sentry controller does not cover damage from overfiring, regardless of the circumstances. It is the operator's responsibility to make sure the kiln turns off at the end of the firing. Follow these safety rules in addition to the ones in your kiln or furnace manual.

When the kiln is not in use, disconnect the power and keep the lid or door closed. (For larger kilns with heavy cordsets, we recommend a power disconnect box near the kiln.)



Do not leave the kiln unattended, especially near the expected shut-off time.

Wear firing safety glasses when looking into peephole of a hot kiln.

Do not touch hot sides of kiln or furnace. Keep unsupervised children away.

Install your kiln or furnace at least 12 inches from any wall or combustible surface. (See manufacturer's recommendation for your model.)

Do not open lid or door until kiln or furnace has cooled and all switches are off.

Fire only in a well-ventilated, covered and protected area away from flammable materials. Keep cordset away from hot sides of kiln or furnace.

DANGEROUS VOLTAGE! Do not touch heating elements with anything. Disconnect kiln or furnace before servicing.

Do not operate if the controller itself is hotter than 150°F/66°C. (See instructions on page 20 for checking board temperature.) Never allow the firing room temperature to exceed 110°F/43°C. (Measure room temperature three feet from the kiln.)

Stop a firing by pressing the STOP button, not by disconnecting the power. In certain conditions, the controller will interpret a power interruption as a power failure and turn the kiln back on when you reconnect the power.

Chapter 1 Basic Pointers



Which Instructions Apply to Your Controller

The Sentry fires in two modes:

- **Ceramic Cone-Fire**, based on pyrometric cones.
- **Ramp-Hold**, based on custom firing rates and target temperatures.

Ceramic kilns use both Cone-Fire and Ramp-Hold. Heat treating, glass fusing, and enameling furnaces and kilns come with Ramp-Hold only.

1 From **Idle** display, press **1**. If **CONE** appears, you have Cone-Fire mode. If the **1** key does not respond, you have Ramp-Hold mode only.

2 Press **STOP** to bring the controller back to **Idle**.

Note: FAST, MEDIUM, SLOW, CONE-FIRE, and CONE #s printed on the controller faceplate apply only to Cone-Fire mode.

If you have Ramp-Hold only, skip pages 8 - 11.

Room Temperature and Humidity

It is okay to store the Sentry at sub-zero temperatures. But before operating, raise the room temperature to at least 32°F/0°C.

Note: The Sentry will register sub-zero °F/°C temperatures. However, 32°F/0°C is the lowest recommended operating temperature.

The circuit board is rated for 158°F/70°C maximum operating temperature. However, the maximum recommended temperature is 125°F/52°C. Open windows and exhaust hot air from the room to lower temperature. (See page 20 to check circuit board temperature.)

High humidity will not adversely affect the Sentry unless water condenses on the circuit board. In this case, do not fire the kiln until the moisture has evaporated from the board.

Thunder Storms and Power Surges

Unplug the kiln when not in use, especially during thunder storms and in areas with frequent power surges. If the kiln is part way through a firing when a storm begins, it may be okay to continue the firing. When the kiln shuts off, disconnect the power.

CAUTION: when firing the kiln during a storm, do not leave the kiln unattended!

Display Lights



Single Center Light: Time

A lower center dot appears during time display. It separates hours from minutes (i.e. 1 hour, 30 minutes displays as 01.30). During temperature display, the dot disappears.



Power Output Lights

The Sentry turns on the heating elements intermittently through relays. The power output lights in the right side of the display appear when the Sentry sends power to the relay(s).

- **Single Zone Kiln** When the Sentry sends power to the relays, all three lights appear.
- **Two Zone Kiln** The top light shows power to the relay for the top section of the kiln. The bottom light shows power to the bottom. Ignore the center light.
- **Three Zone Kiln** The top light indicates power to the top section relay, the middle light to the middle section, and the bottom light to the bottom.

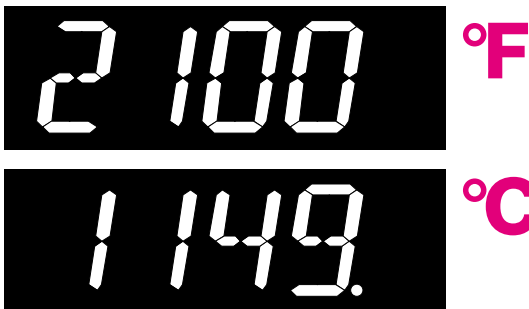

Single Right-Hand Light: °C

When temperature is displayed in °C, a light appears in the lower right. In °F it disappears.

How to Get IdLE to Display

The controller displays **IdLE** when you first apply power to the kiln. Operations begin from **IdLE**. You can't fire the kiln until **IdLE** appears.

- If you press **STOP** during a firing, **AbRT** will appear. To get back to **IdLE**, press **ENTER**.
- If the display shows an error message such as **FAIL** instead of **IdLE**, see pages 22 - 23.
- **CPLT** (firing completed) appears at the end of a firing. To make **IdLE** appear, press any key.

Firing Completion Message

When the firing has completed, four messages will cycle one after the other:

- 1 **CPLT** (complete)
- 2 Firing time in hours and minutes (amount shown does not include Cone-Fire slow cooling time)
- 3 The temperature the kiln fired to in Cone-Fire, or the temperature of the last segment in Ramp-Hold
- 4 The current kiln temperature

Note: If the alarm (see page 6) sounded, and then the kiln fired to completion, you will see **ALAR** instead of **CPLT**. Press **ENTER**. **CPLT** will appear.

Repeat Firings

To repeat the last firing, press **ENTER** from **IdLE**. The kiln will begin firing. This works in both Cone-Fire and Ramp-Hold. But first, make sure you are repeating the correct firing by using "Program Review" (see page 6). For repeat firings that you don't want to inadvertently change, see "Program Lock," page 20.

Thermocouple Inspection

The small rod protruding into the firing chamber is the temperature sensor, or thermocouple.

CAUTION: Bumping the thermocouple can push it out of the firing chamber. This could cause an overfire! The controller does not contain an alarm to detect this type of failure.

Thermocouples come in different widths. The wider the thermocouple, the farther it should extend into the firing chamber. A ¼" diameter thermocouple should extend into the firing chamber about 1". A 1/8" thermocouple should extend into the chamber ½" - 5/8".

Keep shelves, posts and ware 1" - 1 ½" away from the thermocouple. Keep an extra thermocouple on hand, especially if you fire hotter than 2000°F/1093°C.

If you are using a portable, separate controller, you will need to install the thermocouple onto the kiln. See the separate TnF 2 installation instructions.

The "Lid" Display

Reasons **Lid** appears in the display:

- The kiln is equipped with the optional safety switch. (The switch turns off power to the elements when the lid or door is open.) **Lid** appears in the display while the lid is open during firing.
- On the back of the Sentry circuit board, at the top right side, is a small two-pin terminal. If the connector on that terminal is missing, **Lid** will appear in the display during firing. The elements will not turn on. (If the two-pin connector is missing, you can buy another from a computer supply store.)
- The safety lid switch is defective or the safety switch wire is broken.



Chapter 2 The Keys

Correcting Entries

If you enter the wrong temperature, cone, time, etc., while programming, enter 0000. Then enter the correct numbers before pressing **ENTER**. See also the Stop/Back Key, page 7.

1 / Cone Fire

**CONE
FIRE**

Cone-Fire is a method of firing ceramics to a pyrometric cone. See Chapter 3, page 8, for details. To find out if your Sentry includes Cone-Fire:

1 From **IdLE** display, press **1**. If **CONE** appears, you have Cone-Fire mode. If the **1** key does not respond, you have Ramp-Hold mode only.

2 Press **STOP** to bring the controller back to **IdLE**.

2 / Add Time

**ADD
TIME**

This key adds five minutes to a Hold. It is designed for ceramists who watch witness cones through the peephole, and for glass artists who inspect the glass near the end of firing.

1 During a firing, press Add Time. **HOLD**, and time in hold, will appear.

2 Press Add Time again. The time shown will increase by 5 minutes. In a few seconds, temperature display will return.

Note: Add Time will add 5 minutes to Hold in either Cone-Fire or Ramp-Hold, even if no hold had been programmed. After hold time displays, 5 minutes are added with each press of the key.

3 / Delay

DELAY

This delays the start of the firing by the amount of time entered. Use it to fit a firing into your schedule or to take advantage of

lower electric rates at night. Delay zeroes out after each firing. Therefore, it must be programmed for each firing.

1 A Cone-Fire or Ramp-Hold program must be in active memory, ready to fire. (See pages 10 and 13.)

2 From **IdLE** press 3. Enter delay time (i.e., 5 ½ hours = 05.30). Press **ENTER**.

3 To begin Delay, press **ENTER** once from **IdLE**. A Delay count-down timer will appear.

Note: Press **START** during delay to end the delay and begin the firing. The maximum delay is 99 hours and 59 minutes.

CAUTION: For safety, do not leave the kiln alone during a delay or a firing. We cannot guarantee your kiln against overfiring even though the controller is

automatic. The operator assumes full responsibility for shutting the kiln off at the proper time.

4 / Ramp Hold

**RAMP
HOLD**

Ramp-Hold fires the kiln to the temperature you specify, whereas Cone-Fire fires to a pyrometric cone. Press **4** from **IdLE** to program a firing or to select a stored program. See “Ramp-Hold,” page 12.

5 / Present Status

**PRESENT
STATUS**

Press **5** during a firing to display the current segment that is firing. The messages that can appear in Present Status:

- **RA 1** Ramp (see page 12), and segment number.
- **Hd 1** Hold (see page 12), and segment number.
- **PRHT** Cone-Fire Pre-Heat (see page 9).
- **COOL** Cone-Fire Slow Cooling (see page 11).

Uses for Present Status:

- You are firing a program that contains several heating and cooling segments. Without Present Status, it would be easy to lose track of which segment is firing.
- In Cone-Fire, you may think the kiln has fired too long when it is actually only in a slow cooling.

6 / Program Review

**PROGRAM
REVIEW**

When you press **ENTER** to begin firing, the controller will fire the program that is in active memory. Program Review shows the values for that program. The program in active memory is—

- The program that was fired last, or
- The program that was selected since the last firing.

Start Program Review from **IdLE**, or while firing, by pressing **6**.

Note: In Program Review, Cone-Fire Fast speed displays as **F 20**. Slow speed displays as **S 20**. (These speeds are 20% faster and slower than the standard speed.)

7 / Alarm

ALARM

The alarm sounds when the kiln reaches the alarm temperature you enter. Use the alarm to alert you to—

- Lower the lid from venting position (ceramics).
- Check the witness cone near shut-off time (ceramics).
- Check the fusing or slumping of glass.
- Remove the knife blade from the furnace at the end of heat treating.

You can enter only one alarm temperature at a time. However, after the alarm beeps, you can set the alarm for another temperature, as many times as you want, during the firing. You can enter a higher or lower temperature than the current temperature. Entering an alarm temperature automatically erases the previous alarm temperature.

Setting Alarm From Idle

1 From **Idle**, press **7**. **ALAR** will appear alternating with the last alarm temperature entered.

2 Enter alarm temperature. Press **ENTER**. **Idle** will appear. (Enter **0000** to turn alarm off.)

Note: **9999**, as an alarm temperature, automatically changes to the maximum temperature rating of your controller.

When the alarm sounds, shut it off by pressing any key except **STOP**. (The **STOP** key does not work while an alarm sounds.) If the alarm sounds as soon as firing begins, it is because the alarm was set to a temperature below the current temperature.

Setting Alarm During Firing

1 The alarm beeps while the kiln is firing. Press **7**.

2 Enter the new temperature.

3 Press **ENTER**. The kiln will continue firing.

If you touch **7**, enter a new temperature, and forget to press **ENTER**, the controller will merely continue firing.

Note: When an alarm sounds, firing to completion does not shut the alarm off.

9

**CONE #s/
SKIP SEG**

9 / Cone Numbers & Skip Segment

Cone Table

Look up a cone temperature with the **9** key.

1 From **Idle**, press **9**. **CONE** will appear, then the cone, if any, currently programmed in Cone-Fire.

2 Enter a pyrometric cone number. Press **ENTER**. The display will show the cone temperature. If you enter a non-existent cone number, the display will show **CONE**, ready for you to enter a different cone number.

Note: Do not be concerned if the actual cone shut-off temperature does not match the Cone Table. The temperature of a cone varies with firing speed. The cone temperatures in Cone Table are for self-supporting cones fired at a rate of 108°F / 60°C per hour during the last hour of firing.

Skip Segment

Skip Segment works only during firing. It jumps from the current segment to the next one.

To skip a segment, press **9**. **SKIP** will appear, then the current segment. Press **ENTER**. (If you change your mind and don't want to skip that segment, don't press **ENTER** after **SKIP** appears. Instead, press **9** again. The firing will continue in the same segment.)

Skip Segment in Cone-Fire

In Cone-Fire, Skip Segment works in Pre-Heat and Hold:

■ To skip out of Pre-Heat and begin the cone firing.

■ To skip out of Cone-Fire Hold. Slow Cooling will begin. (If the firing does not include Slow Cooling, Skip Segment will not end a Hold. Press **STOP** to end the firing.)

Skip Segment in Ramp-Hold

In Ramp-Hold, the firing will skip to the ramp of the next segment from either a ramp or hold of the current segment. (See page 12 for details on ramps, holds, and segments.)

Skip Segment Examples

For additional examples, see Chapter 4, pages 14 - 15.

Cone-Fire

■ In Cone-Fire you are firing to an 05 witness cone for the first time. You select cone 04 with a 60 minute hold and a slow cooling. After 30 minutes in hold, the 05 witness cone bends to maturity. Use Skip Segment to end the hold and begin Slow Cooling.

Note: Once you know how much hold time will bend the witness cone, program that much hold for the next firing.

Ramp-Hold

■ **Skipping to a Cooling Segment:** You have programmed 2167°F for a cone 5 glaze firing, followed by a segment for controlled cooling. Watching the witness cone through the peephole, you notice that cone 5 is bending at 2150°F. Use Skip Segment to end the firing segment and begin the one for slow cooling.

Note: Make a note of the temperature at which the cone bent. Program that temperature for the next firing.

■ **Skipping to a Hold:** Skip Segment does not skip from a ramp to a hold. It skips to the next segment. If you need to skip to a hold, program an additional segment with the hold that you want. Then skip to that segment. Example:

Segment 1: rate 500°F to 1828

Segment 2: rate 200°F to 1750 with 30 minute hold

Enter/Start

**ENTER/
START**

■ Press **ENTER** after each step in programming a firing.

■ Press **ENTER** once to begin firing.

0

OPTIONS

The Options Key

See Chapter 6, page 17.

The Stop/Back Key

**STOP/
BACK**

You can stop a firing at any time (except when the alarm sounds) by pressing **STOP**.

If you inadvertently enter Ramp-Hold, Cone-Fire, or Options, you do not have to go through all the prompts to get back out. Press **STOP** to go to **Idle**.

The **STOP/BACK** key is also like the Back button on an Internet browser. It works in Cone-Fire and Ramp-Hold programming. It will take you back one step every time you press the key.



Chapter 3 Cone-Fire

1
CONE
FIRE

Cone-Fire mode is based on pyrometric cones. It is not designed for heat treating, glass fusing and enameling. For these firings, see “Ramp-Hold,” page 12. Use Ramp-Hold to fire ceramic pieces that require a custom firing schedule, such as some types of stone-ware sculpture or crystalline glaze.

Pyrometric Witness Cones

The Sentry shuts off automatically without cones. Nevertheless, every ceramic firing should include at least one witness cone (also called the shelf cone). The witness cone is the most accurate measurement of heat work in a ceramic firing.

If you fire the same size load and type of ware regularly, the witness cones let you compare one firing to the next and alert you when something is wrong. For example, if the witness cone bends less and less with each consecutive firing, this may indicate thermocouple temperature drift.

Note: If the bending of the witness cone does not match the Cone-Fire shut-off, you may want to adjust Cone Offset or Thermocouple Offset. See pages 17 - 19. If the witness cones bend inconsistently from one firing to another, see “Sentry Troubleshooter,” a separate publication.

How to Position Cones on the Shelf

Position the witness cones so that you can see them through a peephole during firing. If the kiln takes longer than usual to fire, you may wonder if something has gone wrong and the kiln is overfiring. But by seeing the cones, you will know how the firing is progressing.

If you follow these guidelines, you should be able to see the cones even at cone 10:

- Place the cones 8” - 12” away from a peephole. Positioning them closer makes them difficult to see.
- Have enough space around the cones to keep them from touching a piece of ware when they bend.
- Position cones so that when viewed from the peephole, they are silhouetted by an element on the opposite kiln wall. (Keep cones at least 2” from an element.)

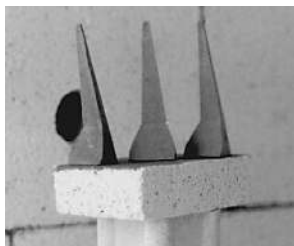

Use self-supporting witness cones on the shelf. They stand upright without cone holders.

- The element that silhouettes the cones should be level with the lower part of the cone. If the element is in line with the upper part of the cone, you won’t be able to see the cone when it bends.

- If you use the three cone system, always have the higher temperature cone on the same side in every firing. Otherwise you can lose track of which cone is which.

- Wear firing safety glasses when viewing the cones through the peephole.

See your dealer if in doubt about which cone number to use with each clay and glaze.

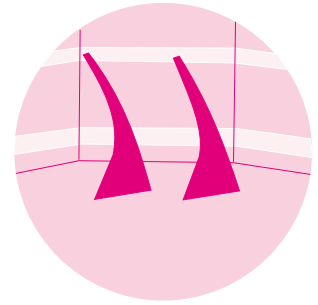

Silhouette the lower part of the cone against an element. Keep the cone 8” - 12” away from the peephole.

Firing Schedules

Cone-Fire uses three firing schedules:

- Low fire cones 022 - 011
- Medium fire cones 010 - 01
- High fire cones 1 - 10

Should you ever want to customize a Cone-Fire program, transfer the firing schedule to Ramp-Hold. See Appendix B, pages 26 - 27.

During a cone firing, press **5** (Present Status) to see which stage, or segment, of the firing the kiln has reached. The number displayed will be a segment number from one of these firing schedules.

Note: Pre-Heat shows in Present Status as **PRHT**. It is not given a separate segment number.

Firing time in each segment is approximate and depends on the age of elements, voltage, size of load, and the firing speed you have chosen.

CAUTION: Cone numbers beginning with 0 are lower in temperature than those without the 0. When programming a Cone-Fire, be sure you know the difference between an 05 and 5. See “Temperature Equivalents Chart for Orton Self-Supporting Pyrometric Cones,” Appendix D, page 30.

Low Fire Cones 022 - 011

This range includes decals, over-decorations, lusters, and golds. The firing can be fast. Good venting is important, because oils and other organics burn off. Do not close the lid from the vented position until all odor has disappeared.

Low Fire Cones 022 - 011 Firing Schedule

Segment	Rate Per Hour	Time in Segment
1	396°F/220°C	2 hours
2	108°F/60°C	1 hour

Firing time is about 3 to 5 hours, depending on the cone and speed.

Middle Fire Cones 010 - 01

Use this range for earthenware and commercial low-fire glazes. Glazes fired on bisque ware (ware that has already been fired) can be fired faster than the unfired greenware. In this cone range, slow firings can produce poor quality glazes.

In the following schedule, the firing is slowed during the silica phase change (1063°F/573°C).

Earthenware and clays that contain ball clays, talc, and kaolin will burn off water, carbon, and sulfur. This reduces weight by 10%.

Cooling too fast can produce glaze pinholes, blisters, and craters. Unless cooling is slowed near 1063°F/573°C, a physical change in the silica can cause the ware to crack. For this reason we recommend that you use Cone-Fire's Slow Cooling option (see page 11).

We recommend a 10 - 20 minute hold when firing lead-free glazes.

Middle Fire Cones 010 - 01 Firing Schedule

Segment	Rate Per Hour	Time in Segment
1	324°F/180°C	2 hours, 30 minutes
2	153°F/85°C	35 minutes
3	180°F/100°C	2 hours, 40 minutes
4	108°F/60°C	1 hour, 30 minutes

Firing time is about 6 to 8 hours, depending on the cone and speed.

High Fire Cones 1 - 10

This is the firing range for porcelain and stoneware. These bodies fire nearly to vitrification and can shrink up to 16%. Water, carbon and sulfur burn out during the early stages and must be vented. The amount of oxygen in the kiln affects the color of the fired clay. The high fire schedule below slows down during the last 210°F/100°C to produce better density in the ware.

Typical porcelain clays are formulated from kaolin, feldspars, silica and ball clays. Weight loss is 10 - 12% and shrinkage is as high as 20%. If overfired, porcelain may warp or blister. Cone-fire's Hold option usually enhances porcelain.

High Fire Cones 1 - 10 Firing Schedule

Segment	Rate Per Hour	Time in Segment
1	324°F/180°C	2 hours, 30 minutes
2	153°F/85°C	35 minutes
3	162°F/90°C	4 hours, 35 minutes
4	108°F/60°C	2 hours

Firing time is about 9 hours, 30 minutes to 11 hours, depending on the cone and speed.

Cone-Fire Features

Speed (SPd)

The Cone-Fire schedules shown on this page are standard. When you select Medium speed in a Cone-Fire program, the kiln uses these standard firing schedules. When you select Fast (1), the standard schedule fires 20% faster. On Slow (3), it fires 20% slower.

You can also alter the firing speed even more under Speed (Spd) in Options. See page 17.

Pre-Heat (PRHT)

Moist greenware can explode during firing. This happens when the moisture in the clay turns to steam rapidly and cannot escape fast enough. The Sentry Pre-Heat feature dries the ware at low temperature before the moisture can turn to steam.

Pre-Heat is sometimes necessary when firing thick greenware, such as stoneware. It may also be necessary in humid weather, which inhibits drying. If possible, however, avoid using Pre-Heat to dry greenware. If the greenware feels damp or cool when you touch it to your cheek, dry it longer before firing. Use a dehumidifier in humid weather. Drying greenware in the kiln tends to rust the kiln.

Note: During Pre-Heat, vent the lid. Otherwise the firebricks will absorb moisture, leading to rust behind the steel case. Moisture in the firebrick can also slow the firing to a crawl.

CAUTION: Venting the lid during Pre-Heat is so important that some ceramists use the extended vent position or even leave the lid open. If you do this, you must be near your kiln at the end of Pre-Heat to lower the lid.

Pre-Heat raises the temperature 60°F/33°C per hour to 200°F/93°C. Then it holds at 200°F/93°C for the time you specify. Pre-Heat works in Cone-Fire only. After Pre-Heat is finished, the kiln will automatically begin firing to the cone you have selected.

Note: At high altitude, water boils at a lower temperature. This may cause moisture in the ware to turn to steam even during Pre-Heat.

1

CONE FIRE

Cone-Fire Programming

Use these instructions for your first firings. Later you may prefer “Cone-Fire Shorthand Programming,” page 32.

As the Sentry prompts for cone, speed, pre-heat, hold, and slow cooling, values entered for the last firing will appear. To use these values again, press **ENTER**.

To fire without Delay or Alarm: Follow steps 1 through 7 below. Then from **Idle** press **START**. To use Delay or Alarm, see also page 6.

- 1 Apply power to the kiln. **8888** then **Idle** will appear. (Press **ENTER** if **Idle** does not appear.)
- 2 Press **1**. **CONE** will appear. Enter cone number. (If the **1** key does not respond, your controller uses Ramp-Hold only.)
- 3 Press **ENTER**. **SPd** will appear. Enter speed: FAST (**1**), MEDIUM (**2**), SLOW (**3**). (Medium speed will display as **Std.**)
- 4 Press **ENTER**. **PRHT** will appear. To use Pre-Heat, enter time. Otherwise enter 0.
- 5 Press **ENTER**. **HOLD** will appear. To soak the ware at the end of firing, enter a hold time. Otherwise enter 0.
- 6 Press **ENTER**. **COOL** will appear. To use Slow Cooling, enter cooling rate as degrees per hour. (180°F/82°C is maximum rate. Press **0** to turn Slow Cooling off.)
- 7 Press **ENTER**. **Idle** will appear.
- 8 **To set Alarm:** Press **7**. **ALAR** will appear. Enter alarm temperature. (Press **0** to turn alarm off.) Then press **ENTER**.
- 9 **To set Delay:** Press **3**. **dELA** will appear. Enter delay time. Press **ENTER**. (Delay zeroes out after each firing.)
- 10 To start program, press **ENTER** once. **STRT** will appear, then temperature. If Delay was programmed, **DELA** will appear, then time remaining until start. To stop the program during firing, press **STOP**.

When program fires to completion, **CPLT** will appear. Press **ENTER**. **Idle** will appear. To shut off the alarm when it sounds during a firing, press **ENTER**.

Mirror Test

This test will help you determine how much Pre-Heat to use. Occasionally during Pre-Heat, hold a mirror near the top peephole. (Be careful to avoid burns.) The mirror must be at room temperature, not hot, so hold it near the peephole for only several seconds.



Vent the kiln until moisture no longer fogs a mirror.

If the mirror fogs, moisture is still escaping from the ware. When the mirror no longer fogs, you can exit Pre-Heat and begin the firing.

To interrupt Pre-Heat and begin firing to the cone in Cone-Fire, press **9** (Skip Segment). **SKIP**, alternating with **1**, will appear. Press **ENTER**. Segment 1 of the firing will now begin. (See Cone-Fire firing schedules, page 9.)

Note: If you are using a vent fan, such as the Orton KilnVent, turn the fan on during Pre-Heat. The fan will help to remove moisture. (AOP Fan users: see the Fan option, page 18.)

How to Use Pre-Heat When Kiln is Above 200°F/93°C at Beginning of Firing

If you begin firing with Pre-Heat in a kiln that is already hotter than Pre-Heat temperature, the kiln will skip Pre-Heat and begin firing to the cone. There are two ways to use Pre-Heat in this situation:

- Wait until the kiln cools below 200°F before starting the firing. This is the preferred method.
- Load the kiln and start the firing, but include enough time in Delay for the kiln to cool below 200°F before Pre-Heat begins.

Hold (HOLD)

Cone-Fire Hold heat-soaks the ware at the cone temperature at the end of the firing. Without Hold, the kiln shuts off after it reaches the cone temperature. Hold maintains the cone temperature for the period you specify. Hold helps even out the temperature throughout the kiln. It also helps the heat to penetrate completely into the clay. (Rapid firing is like cooking: the turkey will be done on the outside but not on the inside.) Hold helps glaze absorb china paint. It helps to heal glaze defects such as bubbles. A little hold time can yield dramatic results.

CAUTION: Too much hold time can overfire your ware and burn out colors.

One way to add Hold time without over-firing is to fire to one cone cooler than needed. Then add enough hold time to bend the next hotter cone. Hold time needed to bend the next cone will vary. As a rule of thumb, 45 - 60 minutes of hold = one cone of heat work.

Example: to fire to cone 05, program Cone-Fire for 06 and add 45-60 minutes of hold time.

Watch the pyrometric witness cones through the peephole. Press **STOP** when the correct witness cone bends, noting how much Hold time was needed. Program that much Hold time the next time you fire the same type of ware loaded to the same capacity.

Note: During Hold, the display temperature will alternate with time left in Hold. To figure hold time for the next firing, subtract time left in Hold from the total Hold time entered.

When Hold is set to 99.99 hours, the Sentry will remain at that temperature indefinitely, until **STOP** is pressed.

Slow Cooling (COOL)

Slow cooling enhances the quality of some ceramic glazes. Slow cooling encourages crystal development, deeper gloss, and sometimes startling color shifts. Iron red glazes seem to respond well to slow cooling. For these reasons we have added a Slow Cooling feature to Cone-Fire.

- Slow Cooling begins after the cone firing (and Hold, if any) and ends at 392°F/200°C.
- When **COOL** appears in Cone-Fire programming, enter a cooling rate between 1°F/C to 180°F/82°C. A good starting point is a rate of 90°F/50°C.
- Enter a rate of 0 to turn Slow Cooling off.

Note: Slow Cooling can extend the firing time by many hours. For instance, if the shutoff temperature is 1945°F/1063°C, and the cooling rate is 100°F/55°C, the kiln will take 15 ½ hours to reach 392°F/200°C.

When the Kiln Shuts Off Too Soon

If the kiln shuts off before the pyrometric witness cone bends, you can turn the kiln back on and keep firing. Simply program the next hotter cone in Cone-Fire. Then from **IdLE**, press **START**. The kiln will begin firing, taking up where it left off.

Note: By looking at the witness cones through a peephole, you will know if the kiln shuts off too soon.

If the kiln shuts off within 100°F/55°C of maturity, and the temperature drops 50°F/28°C or more after the kiln shuts off, do not depend on the witness cones. Once they cool 50°F/28°C after they have been heated to within 100°F/55°C of maturity, they will not bend properly. This is because they form a hard shell.

Wrong Thermocouple Type

If a Type-K thermocouple is installed on your kiln, but your controller is set for Type-S, the kiln will continually underfire by a wide margin. See page 19 to check thermocouple type.

For Kilns with AOP Outlet

The AOP (auxiliary output) is a special-order receptacle mounted in the kiln switch box. The Sentry controls power to the AOP receptacle. The AOP is usually used to power a kiln vent.

The Fan option, which is accessed through the **OPTIONS** key, determines when an AOP-powered kiln vent will operate during Cone-Fire.

Before the Fan option will appear on the Options list, (1) you must enter a Cone-Fire program in active memory and (2) you must select FAN3 in the AOP option. (See page 20 for instructions on selecting FAN3 in the AOP option.)

- 1 From **IdLE**, press **OPTIONS** repeatedly until **FAN** appears.
- 2 Press **ENTER**. Use the **1** and **2** keys to select one of these settings:
 - **ON** The vent is on during Pre-Heat, the cone firing, and Slow Cooling. It turns off at 212°F/100°C.
 - **OPT** The vent is on during Pre-Heat and the cone firing. It is off during Slow Cooling.
 - **OFF** The vent is off all the time.
- 3 After selecting one of the above, press **ENTER**. Press **STOP** to return to **IdLE**.



Chapter 4

Ramp-Hold

4
RAMP
HOLD

Definition of a Segment

Ramp-Hold fires in segments. Every segment must have a target temperature and a heating rate to reach that temperature. Shown in diagram A is a segment with a temperature of 750°.

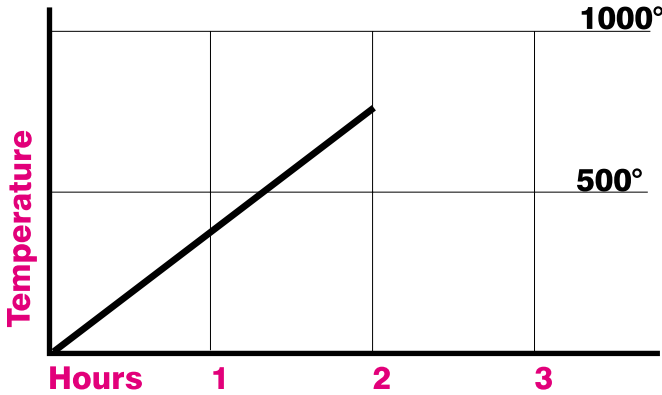

Diagram A: a single segment.

Rate is figured in degrees per hour. In Diagram A above, the temperature takes two hours to reach 750°. The rate is $750 \div 2 = 375$.

Diagram B, below, shows three rates. A rate of 1000° will reach 1000° in 1 hour. A rate of 500° will reach 1000° in 2 hours. A rate of 333° will reach 1000° in 3 hours.

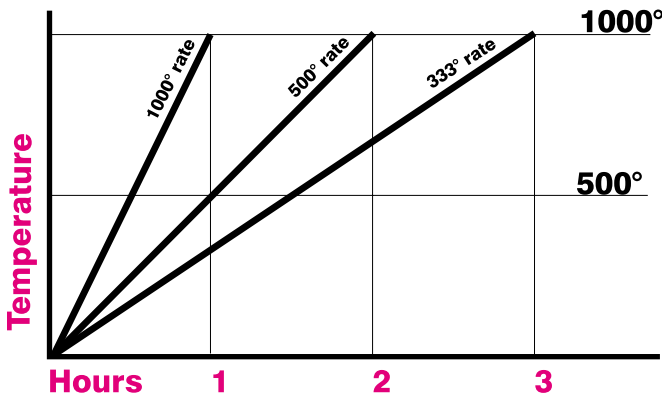

Diagram B: Rate is degrees per hour. This diagram shows 3 rates. Divide the target temperature by the number of hours it took to reach that temperature.

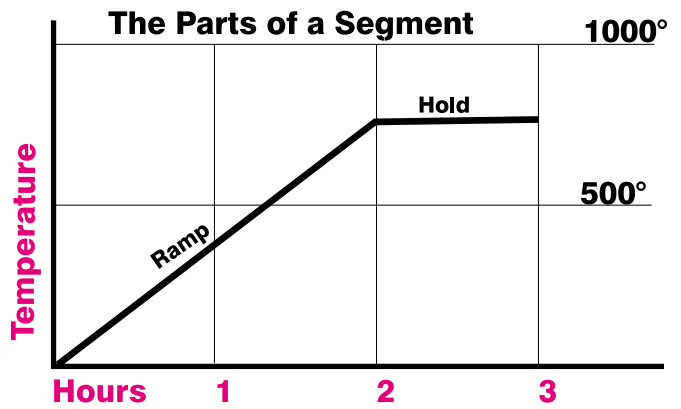

Diagram C: a single segment with hold. The two parts of a segment are the ramp and the hold. Not all segments have a hold, but they all have a ramp.

A segment, which is a target temperature and a rate of heating to reach that temperature, can also have a hold. Hold maintains the target temperature for the length of time you specify. (Diagram C, above.)

A segment has two parts:

- **Ramp:** where the temperature changes
- **Hold:** where the temperature remains the same

A segment can have only one ramp and only one hold. Therefore, if you need more than one hold, you will have to add additional segments to the firing. Firing to a temperature at a single rate would need only one segment. Reasons to add more segments:

- To change the heating rate
- To add a hold somewhere below the shut-off temperature
- To change the temperature direction. Example: to control the cooling rate.

Diagram D, below, shows a 3 segment firing. Two segments were used on the way up in temperature. Another segment was added for controlled cooling.

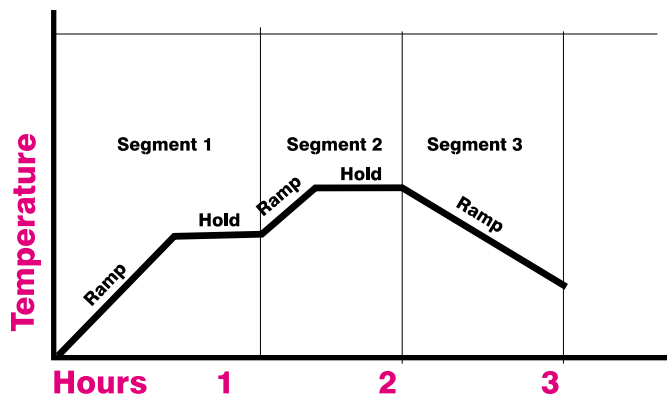

Diagram D: a 3 segment firing. Only 2 segments have a hold.

Ramp-Hold Programming 4 RAMP HOLD

Use these instructions for your first firings. Later you may prefer “Ramp-Hold Shorthand Instructions,” page 31.

As the program prompts for segments, rate, temperature, etc., you will see values from the last firing. To use these again, press **ENTER**. To control cooling, set the segment to a lower temperature than that of the preceding segment.

To fire without Alarm or Delay: Follow steps 1 through 7. Then press **START** once.

- 1 Apply power to the kiln. **8888** then **IdLE** will appear. (Press **ENTER** if **IdLE** does not appear.)
- 2 Press **4**. **USER** will appear. Enter a number from 1 to 4.
- 3 Press **ENTER**. **RA 1** will appear. Enter firing rate for segment 1 (temperature change per hour: from 1° to 9999°).
- 4 Press **ENTER**. **°F 1** (or **°C 1**) will appear. Enter the target temperature of segment 1.
- 5 Press **ENTER**. **Hd 1** will appear. Enter segment 1 hold time in hours/minutes (e.g. 12 hours, 30 minutes = 12.30). No hold = 0.
- 6 Press **ENTER**. If **FN 1** appears, and you have an AOP receptacle on your kiln, select ON or OFF. Press **ENTER**. (For more details on AOP, see AOP option, page 20.)
- 7 Continue entering values for the segments needed. When **RA** appears for the first segment you don't need, press **0**, then **ENTER**. **IdLE** will appear.
- 8 **To set Alarm:** press **7**. **ALAR** will appear. Enter alarm temperature. (Enter **0** to turn alarm off.) Then press **ENTER**. **IdLE** will appear.
- 9 **To set Delay:** press **3**. **dELA** will appear. Enter delay time (i.e. 12 hours, 30 minutes = 12.30). Then press **ENTER**. (Delay zeroes out after each completed firing.) **IdLE** will appear.
- 10 To start program, press **ENTER** once. **STRT** will appear, then kiln temperature. If a delay was programmed, **STRT** will appear, then time remaining until start. To stop the firing, press **STOP**.

We recommend using Program Review (page 6) before firing. When program fires to completion, **CPLT** will appear. Press **ENTER**. **IdLE** will appear. To shut off the alarm when it sounds during a firing, press **ENTER**.

User Programs (USER)

When you enter Ramp-Hold mode, the first prompt to appear is **USER**, meaning, “Select one of your programs.” You, the user, can make your own firing schedules and store them in memory. A firing schedule, or program, is the segments needed for a firing. To make a segment, you will need three facts:

- rate (how fast temperature changes in degrees per hour)
- target temperature
- hold, if any

The controller can retain four user programs in memory even when power is turned off. User programs are numbered from 1 through 4. User program #1 can have up to 20 segments. User programs #2 - #4 can have ten segments each. You don't have to use all 20 or all 10 segments—only the number needed per firing. Often one segment is all you will need. A User program can be as simple as a single ramp.

When using Ramp-Hold for the first time, press **1** when **USER** appears. Your first firing will be stored as User Program #1.

Each time you store another program, select another available number, such as 2, at the **USER** prompt. Adding a program to a user number over-writes any existing program stored there. Write down your User Programs.

Note: If you don't need all the segments available in a User program, zero out the unused segments. First, enter values for the segments needed. At the

Segment	Rate of	Temperature	Hold
1	100	350	—
2	180	950	.20
3	350	2250	.20
4	9999	2100	.10
5	65	1910	.40

Write down each program stored in memory. Before firing, use Program Review to be sure everything is correct.

RA prompt for the segment you don't need, press **0**, then **ENTER**. The display will return to **IdLE**.

Note: For repeat firings that you don't want to inadvertently change, see Program Lock, page 20.

Firing a Stored User Program

To use a stored program, press 4 from IdLE. Enter the program number at the **USER** prompt. Press **ENTER**. If there are no changes to the program, press **STOP**. **IdLE** will appear. The controller is ready to fire your selected program. To begin firing, press **ENTER** once. (Use “Program Review,” page 6, before firing. See also “Repeat Firings,” page 5.)

Rate

As stated before, each segment must include a rate, programmed as degrees of temperature change per hour.

The kiln will fire at full power when the rate is 1799°F/999°C or higher. Programming a rate of 9999 is the easiest way to program a maximum rate.

Note: In Program Review, 9999 is displayed as **FULL**. When a kiln is heated at full power, it may over-shoot the target temperature, especially in the lower range. To avoid this, add an extra segment with a slower rate for the last 20 degrees of temperature rise.

CAUTION: The Sentry includes error messages to warn you when the kiln is at the wrong temperature. Firing the kiln at full rate turns off some of these warnings. For details, see “Temperature Deviation,” page 20.

If you are not sure how fast to fire, remember an old firing adage: “When in doubt, slow it down.”

Hold (HOLd)

Hold maintains the temperature of a segment for the time you specify. Hold gives the temperature time to become more even throughout the kiln. Hold can be used in either heating up or cooling down segments.

Ceramics: Wearing firing safety glasses, watch the witness cone near the end of the firing. (See page 8.) When the witness cone bends, note the hold time. The next time you fire the same type of ware loaded to the same capacity, program that amount of hold time.

Note: During Hold, the display temperature will alternate with time left in Hold. To figure hold time needed for the next firing, subtract time left in Hold from total Hold time entered.

When Hold is set to 99.99 hours, the Sentry will remain at that temperature indefinitely, until **STOP** is pressed.

AOP Fan

The optional AOP (auxiliary output) is a special-order electrical receptacle mounted in the kiln’s switch box. This receptacle can power a kiln vent or external alarm. (See Options, page 20.) In Ramp-Hold, the prompt for the AOP outlet is **FN**, which can be turned on or off for each segment.

Segments for Controlled Cooling

For controlled cooling, program a segment to a lower temperature than that of the preceding segment.

If you prop the lid for a fast cooling, program a fast cooling rate. If you program a slow cooling rate, but lower the temperature quickly by propping the lid, the controller will defeat your fast cooling. It will raise the temperature again.

Glass fusers sometimes flash-cool the glass at the end of fusing. They lift the lid slightly to remove heat, then close it again. This takes the glass down rapidly through the devitrification range. To program a flash-cool, use a rate of 9999.

Suppose you enter a cooling rate that is faster than the kiln is able to cool? Depending on the rate you enter, you may get an alarm message. (Press **ENTER** to turn off the alarm.) **The controller, of course, cannot speed cooling beyond the kiln’s natural cooling rate.**

Note: During fast cooling, do not open the lid/door all the way. Do not force-cool the kiln with a fan.

Sample Firing Schedules

These sample firing schedules illustrate different ways to use your Sentry. When designing a firing schedule for materials you are unfamiliar with, or when using one of these schedules, test-fire samples first.

Cone-Fire Program Fired in Ramp-Hold

The following firing schedule is the cone 04 Cone-Fire schedule at standard (medium) speed. (See pages 26 - 27.) A slow-cooling segment was added.

Segment	Rate °F/°C	Temp. °F/°C	Hold
1	324/180	1022/550	00.00
2	153/85	1112/600	00.00
3	180/100	1837/1003	00.00
4	108/60	1945/1063	00.00
5	150/83	1000/537	00.00

In this schedule, the kiln will cool at 150°F/83°C per hour to 1000°F/537°C. Some ceramists use slow cooling with certain glazes.

Sculptured Stoneware Bisque Firing Schedule, Cone 04

Rate Segment	Temp. °F/°C	°F/°C	Hold
1	60/33	200/93	03.00
2	80/44	700/371	02.00
3	80/44	1100/593	00.00
4	108/60	1945/1062	00.00
5	150/83	1400/760	00.00

This slow firing is for thick stoneware. Change the target temperature in segment 4 when firing to a different pyrometric cone. The ware should be bone dry. Test samples until you are sure the schedule works for your clay.

If you are not using a kiln vent, leave peephole plugs out and vent the lid. Set the alarm to 1000°F. When the alarm sounds, close the lid from venting position.

Set the alarm again, this time to 1850° F. When it sounds, check the witness cone through the peephole. When the cone bends to six o'clock, write down the temperature. (Use that temperature in segment 4 on your next firing of the same type of ware.) Then press **9, ENTER** (Skip Segment).

This will advance you to segment 5, a slow cooling segment. Do not open the lid until the kiln has cooled to room temperature.

Glass Fusing Firing Schedule

Segment	Rate °F/°C	Temp. °F/°C	Hold
1	250/138	750/398	00.00
2	900/500	1425/773	00.30
3	9999/9999	1050/565	00.00
4	150/83	750/398	00.00

Stained glass, 1/8", 2 layers, full fuse. The fusing temperature will vary depending on the brand of glass, the batch, and even upon the color. Vent the lid. Set the alarm to 500°F. When the alarm sounds, close the lid from venting position and insert peephole plugs.

Set the alarm again, this time to 1350°F. When it sounds, check the glass through the peephole. When the glass fuses to your satisfaction, write down the temperature and hold time for future firings, and press **9, ENTER** (Skip Segment).

This will advance you to segment 3, a flash cooling segment. Lift the kiln lid slightly or open the door ajar until the temperature drops to 1050° F. Then close the door/lid. The kiln will cool slowly through the annealing range, then turn off.

Note: A cooling rate of 9999 (FULL) shuts off the warning alarm that sometimes sounds during rapid cooling. For more details about alarms, see page 20.

Glass Slumping Firing Schedule

Segment	Rate °F/°C	Temp. °F/°C	Hold
1	250/138	750/398	00.00
2	900/500	1250/676	00.30
3	9999/9999	1050/565	00.00
4	150/83	750/398	00.00

Stained glass, 1/8", 2 fused layers, 12" circular pieces, slumped into a bowl. Set the alarm to 500° F. When the alarm sounds, close the lid from venting position and insert peephole plugs.

Set the alarm again, this time to 1150° F. When it sounds, check the glass through the peephole. When the glass slumps into the bowl, write down the temperature and hold time for future firings, and press **9, ENTER** (Skip Segment).

This will advance you to segment 3, a flash cooling segment. Lift the kiln lid slightly or open the door ajar until the temperature drops to 1050° F. Then close the door/lid. The kiln will cool slowly through the annealing range. Then it will turn off and cool to room temperature.

Note: A cooling rate of 9999 (FULL) shuts off the warning alarm that sometimes sounds during rapid cooling. For more details about alarms, see page 20.

Starting a Firing in a Hot Kiln

Sometimes a firing begins in a hot kiln after a power failure, or other interruption. In this case, the Sentry will begin firing from the first segment that matches the current temperature. See Power Failures, page 23.

When the Kiln Shuts Off Too Soon

Ceramic Firings

If the kiln fires to completion before the pyrometric witness cone bends, you can turn the kiln back on and keep firing. Simply program a hotter temperature. Then from **Idle**, press **START**. The kiln will begin firing, taking up where it left off.

Note: By looking at the witness cones through a peephole, you will know if the kiln shuts off too soon.

If the kiln shuts off within 100°F/55°C of maturity, and the temperature drops 50°F/28°C or more after the kiln shuts off, do not depend on the witness cones. Once they cool 50°F/28°C after they have been heated to within 100°F/55°C of maturity, they will not bend properly. This is because they form a hard shell.

Wrong Thermocouple Type

If a Type-K thermocouple is installed on your kiln, but your controller is set for Type-S, the kiln will continually underfire by a wide margin. See page 19 to check thermocouple type.



Chapter 5 Multiple Zone Kilns

Note: See also Multiple Zone Options, page 21.

An Overview of Multiple Zone Firing

If you are not sure how many zones your kiln has, look into the firing chamber. The number of thermocouple tips indicates the number of zones.

In single-zone kilns, the Sentry measures temperature from one location. When the controller turns on the heat, all the elements turn on.

With two and three zone kilns, the Sentry measures temperature from each individual zone. It then adjusts the heat separately for each zone to improve temperature uniformity.

To maintain even temperature, the Sentry calculates not only temperature difference between zones, but also length of time needed to change temperature. By carefully timing heat output, it maintains even temperature with a minimal loss in firing speed.

Note: Multiple zone kilns use the same Cone-Fire and Ramp-Hold programming instructions as single zone kilns.

Note: Firing a Ramp-Hold program at FULL rate (1799°F/999°C or higher rate) shuts off multiple-zone control for that firing. The kiln then fires as a single zone kiln.

Viewing Zone Temperatures

The temperature displayed during firing is an average taken from all zones. Through the Options key, you can gain more precise temperature readings:

Zone Difference (DIFF)

- 1 Press **OPTIONS** repeatedly until **DIFF** appears.
- 2 Press **ENTER**.
- 3 The maximum difference in temperature between the zones is shown. (Example: **-005**.)

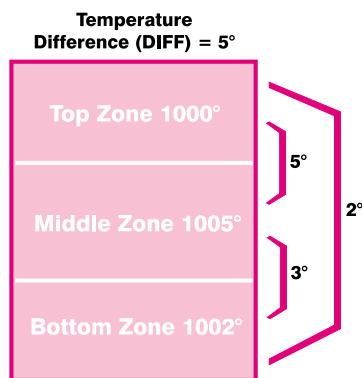

Zone Temperatures (T123)

- 1 Press **OPTIONS** repeatedly until **T123** appears.
- 2 Press **ENTER**.
- 3 The temperature for each zone will display one after the other. This information will cycle for one minute. Then normal temperature display will return. For example:

- Top zone: **TC 1 1250**
- Middle zone: **TC 2 1251**
- Bottom zone: **TC 3 1249**

Two Zone Kilns: Adjust Heat in Center Section (CAJ)

The Center Adjust option is accessed with the Options key. It appears only on 2 zone kilns that contain 3 relays and 3 banks of elements. It does not appear on 2 zone kilns with 2 relays, or on 3 zone kilns.

The Center Adjust acts as an infinite control switch that adjusts heat to the center section of the kiln. A number will display. 100 is the factory default, meaning 100% heat. You can change the setting from 0 to 200. The higher the number, the more the heat in the center section.

- 1 From **IdLE**, press **OPTIONS** repeatedly until **CAJ** appears.
- 2 Press **ENTER**. Use any number key to change the number that appears.
- 3 Press **ENTER**. Press **STOP** to return to **IdLE**.

Thermocouple Failure In a Multiple Zone Kiln

In a multiple zone kiln, if a thermocouple fails, the firing will continue as a single-zone kiln so long as one thermocouple still operates. **FAIL** will appear, alternating with the thermocouple that failed (i.e. **TC 1**).

Power Output Lights

The 3 lights to the right of the temperature display turn on when the controller sends power to the relays.



■ **Two Zone Kiln** The top light shows power to the relay for the top section of the kiln. The bottom light shows power to the bottom. Ignore the center light.

■ **Three Zone Kiln** The top light indicates power to the top section relay, the middle light to the middle section, and the bottom light to the bottom.

Testing Multiple Zone Elements

When relays or thermocouples are connected to the wrong controller terminals, zones will show a wide temperature difference. To wire the kiln properly, trace the switch box wiring with the kiln's wiring diagram. Also, see "Element Test," page 21.



Chapter 6 Options



The Options key gives you access to a list of features. With each press of the Options key, you will see the display code for the next option.

- 1 When you find the option you want to use, press **ENTER**.
 - 2 Use the **1** and **2** keys to select changes within the option.
 - 3 After making a selection for an option, press **ENTER**. The display code for the option you just changed will appear. You are then ready to go to the next option.
- In Cone-Fire mode, you will see more options than in Ramp-Hold mode.
 - If you select a change for an option but don't press **ENTER**, the change will not go into effect.

There are two ways to get out of Options and back to **IdLE**:

- 1 Press **STOP**. If you are firing the kiln while in Options, pressing **STOP** takes you out of Options and back to the firing display. But it does not stop the firing.
- 2 Do nothing for 60 seconds in Options. You will automatically be taken out of Options.

Cone-Fire Options

These options appear only if a Cone-Fire program has been selected. If your kiln has Ramp-Hold only, skip to "General Options," page 18.

Cone-Fire Speed (Spd)

Adjust Cone-Fire Speed Beyond Slow, Medium & Fast

There are two ways to adjust the speed of a cone fire:

- 1 Select Fast (1), Medium (2), or Slow (3) when programming a firing.
- 2 Choose a speed In the Speed (Spd) option.

Every cone has a standard firing schedule. Select Medium speed (the 2 key) during Cone-Fire programming, and the cone will fire to the standard schedule. Select Fast (1), and the standard schedule will speed up by 20%. Select Slow (3), and the standard schedule will slow down by 20%.

In the Speed option, you can further adjust the speed of a standard schedule 10 - 40% slower or faster:

- 1 First, program a Cone-Fire.
- 2 After programming a Cone-Fire, **IdLE** will appear. From **IdLE**, press **OPTIONS** until **SPd** appears.

- 3 Press **ENTER**. Use the **1** or **2** key to scroll through this selection:

- Std** Same as Medium in cone programming.
- F10** 10% faster than standard
- F20** Same as Fast in cone programming
- F30** 30% faster than standard
- F40** 40% faster than standard
- S40** 40% slower than standard
- S30** 30% slower than standard
- S20** Same as Slow in cone programming
- S10** 10% slower than standard

When the speed of choice appears, press **ENTER**.

- 4 To go back to **IdLE**, press **STOP**.

The kiln is now ready to fire with the new speed.

Note: Program Cone-Fire before using the Speed option. Programming Cone-Fire after selecting a speed in Speed option will change the speed to Medium, Slow or Fast.

Cone Offset (OFST)

Calibrate Cone-Fire to a Shelf Cone

Sometimes the pyrometric cone programmed in Cone-Fire does not match the bending of the witness cone. Cone Offset will adjust Cone-Fire to fire hotter or cooler.

Each time you use Cone Offset, you alter the temperature for only one of the three ranges of cones:

- Low fire cones 022 - 011
- Medium fire cones 010 - 01
- High fire cones 1 - 10

The range of cones affected a Cone Offset is determined by the cone programmed to fire when you enter Cone Offset.

Example: You have programmed an 05 cone in Cone-Fire. By changing Cone Offset, you change not only the firing of the 05 cone, but all medium fire cones from 010 to 01.

Adjusting one range of cones has no effect on the other two. To adjust all the cones equally, use Thermocouple Offsets, page 18.

Note: Use Cone Offset to adjust one particular temperature range of cones. Use Thermocouple Offset to make an overall adjustment for all cones.

Follow these guidelines before deciding that you need to use Cone Offset:

- The thermocouple must protrude into the firing chamber the correct distance: about 1" for 1/4" wide thermocouples, 1/2" - 5/8" for 1/8" wide thermocouples.
- Keep shelves 1" - 1 1/2" away from the thermocouple.
- Keep witness cones at least 2" away from heating elements.

- Place witness cones in several locations in the kiln.

How to Use Cone Offset

Cone Offset changes the shut-off point of the cone by the degrees of temperature shown in the chart below.

- 1 From **IdLE**, press **OPTIONS** until **OFST** appears.
- 2 Press **ENTER**. The current Cone Offset adjustment number will appear.
- 3 Using the **1** and **2** keys, select a new adjustment number (see chart below). Then press **ENTER**. **OFST** will appear. To return to **IdLE**, press **STOP**.

Cone Offset Settings

Note: select a cone in Cone-Fire before changing Cone Offset.

°F Setting	°C Setting	Result
0	0	No adjustment
5	3	Kiln will fire hotter
10	6	Kiln will fire hotter
15	8	Kiln will fire hotter
20	11	Kiln will fire hotter
-5	-3	Kiln will fire cooler
-10	-6	Kiln will fire cooler
-15	-8	Kiln will fire cooler
-20	-11	Kiln will fire cooler

Cone Offsets remain in memory for future firings unless you use the Reset option (page 21).

Interpreting Cone Bending

Position the witness cone in the kiln according to instructions on page 8.

The cone bent to 6 o'clock: No calibration in Cone Offset needed. The self-supporting cone has fired to maturity when the tip is even with the base as shown.



The cone did not bend far enough: Use a positive Cone Offset number for a hotter firing, such as 20 (°F).

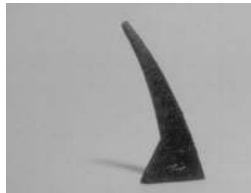

The cone bent too far: Use a negative Cone Offset for a cooler firing, such as -20 (°F).



Note: Do not be overly concerned with achieving an exact 6 o'clock bend. The difference between a 3 o'clock and a 6 o'clock bend is only a few degrees.

When Cone Temperature Is Off More Than 20°F/11°C

The maximum amount that Cone Offset can change the temperature is 20°F/11°C. When the temperature is off more than that amount, correct with Thermocouple Offset.

Fan (FAN)

Control the Optional AOP Receptacle in Cone-Fire

The AOP (auxiliary output) is a special-order kiln switch box receptacle. The Sentry controls power to the AOP receptacle. The AOP is usually used to power a kiln vent. The Fan option determines when an AOP-powered kiln vent will turn on during Cone-Fire.

Before the Fan option will appear on the Options list, (1) you must enter a Cone-Fire program in active memory and (2) you must select **FAN3** in the AOP option. (See page 20 for instructions on selecting **FAN3** in the AOP option.)

- 1 From **IdLE**, press **OPTIONS** repeatedly until **FAN** appears.
- 2 Press **ENTER**. Use the **1** and **2** keys to select one of these settings:
 - **ON** The vent is on during Pre-Heat, the cone firing, and Slow Cooling. It turns off at 212°F/100°C.
 - **OPT** The vent is on during Pre-Heat and the cone firing. Then it shuts off. (It is off during Slow Cooling.)
 - **OFF** The vent is off all the time.
- 3 After selecting one of the above, press **ENTER**. Press **STOP** to return to **IdLE**.

General Options

General options are available on all Sentry controllers.

Thermocouple Offset (TCOS)

Calibrate the Thermocouple(s)

The thermocouple is the rod protruding into the firing chamber. It measures temperature. Thermocouples can "drift" as they age, causing a shift in temperature readings. Thermocouple Offset calibrates the controller to compensate for drift.

Note: The thermocouple must protrude into the firing chamber the correct distance: 1" for ¼" wide thermocouples, ½" - ⅝" for 1/8" wide thermocouples.

Thermocouple Offset for Ceramic Firings

In ceramics, Cone Offset (see page 17) adjusts only one range of pyrometric cones without affecting the other cones. Thermocouple Offset, on the other hand, affects all cones, and all Ramp-Hold firings, equally. A 5° hotter setting in Thermocouple Offset fires everything 5° hotter.

Note: If you find that all your cones are consistently under- or over-firing, adjust Thermocouple Offset. If you need to adjust only a particular cone, use Cone Offset.

Calibrating Thermocouple Offset With a Digital Pyrometer

You can calibrate Thermocouple Offset using a calibrated digital pyrometer. One way to calibrate your pyrometer is to take it to a heat treater or other location that has a calibrated controller you can trust. Take a reading from a furnace with your pyrometer. Either zero it out to match the calibrated controller on the furnace, or write down the temperature difference between your pyrometer and the reliable source. Store your pyrometer. Use it only for calibrating controllers. Thus, it remains a reliable calibration standard.

Note: The temperature at which you calibrated your digital pyrometer should be the same temperature you use to check the controller's temperature readout. Example: if you took a reading from a reliable source at 2000°F, you should check the controller reading at around 2000°F.

Mount the thermocouple of the calibrated pyrometer in the firing chamber near the Sentry's thermocouple. With the Sentry on Hold, compare readings between the Sentry and the calibrated pyrometer. Adjust Thermocouple Offset to compensate for any temperature difference between them.

Setting Thermocouple Offset

You can enter a temperature change up to 45°F/25°C higher or lower than the zero factory setting.

- 1 From **IdLE**, press **OPTIONS** repeatedly until **TCOS** appears.
- 2 Press **ENTER**. **C 0**, or a Thermocouple Offset, will appear.
- 3 Using the **1** and **2** keys, enter the new offset. (See chart below.) Press **ENTER**. **TCOS** will appear. To return to **IdLE**, press **STOP**.

Thermocouple Offset Settings

°F Setting	°C Setting	Result
C 0	C 0	No adjustment
H 1-45	H 1-25	Kiln will fire hotter
C 1-45	C 1-25	Kiln will fire cooler

Thermocouple Offset Examples

Setting	Result
H 1	Kiln will fire 1° hotter
H 17	Kiln will fire 17° hotter
C 12	Kiln will fire 12° cooler

Multiple Zone Thermocouple Offset

- 1 From **IdLE**, press **OPTIONS** repeatedly until **TCOS** appears.
- 2 Press **ENTER**. **TC1** (top thermocouple) will appear.
- 3 While **TC1** displays, press **OPTIONS**. The other thermocouple(s), then **TCOS**, will appear with each press of the **OPTIONS** key.
 - 3 zone kilns: **TC1** **TC2** **TC3** **TCOS**
 - 2 zone kilns: **TC 1** **TC3** **TCOS**

- 4 When the correct thermocouple appears, press **ENTER**.
- 3 Using the **1** and **2** keys, enter the new offset. (See charts at left.) Press **ENTER**. The thermocouple you adjusted (i.e. **TC**) will appear. Select another thermocouple, or return to **IdLE** by pressing **STOP**.

Selecting °F or °C (CHG-)

The controller operates in your choice of °F or °C temperature. In °C display, a lighted dot appears in the lower right. In °F, it disappears. To switch from °F to °C or vice versa:

- 1 From **IdLE**, press **OPTIONS** repeatedly until **CHG-** appears.
- 2 Press **ENTER**. Use the **1** and **2** keys to select **°F** or **°C**.
- 3 After selecting one of the above, press **ENTER**. Press **STOP** to return to **IdLE**.

°F/°C Temperature Conversion Formula

Below are formulas for converting temperature between °F and °C. Converting a firing rate requires a different formula than firing temperature:

Firing Temperature

(i.e. "Fire to 1600°F." 1600°F = 871°C)

$$(^{\circ}\text{C} \times 1.8) + 32 = ^{\circ}\text{F}$$

$$(^{\circ}\text{F} - 32) \div 1.8 = ^{\circ}\text{C}$$

Firing Rate and Temperature Change

(i.e. "Fire at 200°F per hour" or "Fire 200°F hotter." 200°F = 111°C)

$$^{\circ}\text{C} \times 1.8 = ^{\circ}\text{F}$$

$$^{\circ}\text{F} \div 1.8 = ^{\circ}\text{C}$$

Thermocouple Type (TC)

Select Type-K, S or R Thermocouple

The Sentry can be used with Type-K, S or R thermocouples. If you specialize in firings above 2200°F/1204°C, you should use the Type-S or R. Type-K is best suited for temperatures below 2200°F/1204°C.

CAUTION: Be careful about changing the thermocouple type!

If you select Type-S or R, but your kiln is wired with a Type-K, your kiln will underfire. If you select Type-K and your kiln is wired with a Type-S or R, your kiln will OVERFIRE. After using the Reset (RST) option (page 21), make sure you have the correct thermocouple selected. Reset changes thermocouple selection to Type-S!

- 1 From **IdLE**, press **OPTIONS** repeatedly until **TC** appears.
- 2 Press **ENTER**. Use the **1** and **2** keys to select **TC K**, **TC R** or **TC S**.
- 3 After selecting one of the above, press **ENTER**. Press **STOP** to return to **IdLE**.

AOP Outlet (AOP)

Select Vent Fan or Alarm for the Auxiliary Output

The optional “AOP” (Auxiliary Output) is an electrical receptacle mounted in the kiln’s switch box. This outlet can power a kiln vent or an external alarm, such as a bell. The AOP is a special-order option that might not be on your kiln.

The choices in the AOP option:

- **ALAR Alarm:** This choice sends power to the AOP receptacle whenever the alarm sounds. (See Alarm, pages 6 & 7.) Plug in a loud bell to alert you, from a distance, that the kiln has reached the alarm temperature.
- **NONE None:** Use this setting if your kiln does not have the AOP outlet.
- **FAN2** Do not use FAN2.
- **FAN3 Kiln Vent:** This option adds a prompt for fan (**FN**) to each segment in Ramp-Hold (page 13). For Cone-Fire controllers, selecting FAN3 makes the FAN option visible on the options list (page 18).
 - 1 From **IdLE**, press **OPTIONS** repeatedly until **AOP** appears.
 - 2 Press **ENTER**. Use the **1** and **2** keys to select **ALAR FAN3** or **NONE**.
 - 3 After selecting one of the above, press **ENTER**. Press **STOP** to return to **IdLE**.

Computer ID (ID)

Enter an ID Number for Connection to a Computer

This feature is for assigning an identification number, from 1 to 15, to the controller. It is used only for hookup to a personal computer and requires an optional kit.

- 1 From **IdLE**, press **OPTIONS** repeatedly until **ID** appears.
- 2 Press **ENTER**. Use the **1** and **2** keys to select an ID number from 1 to 15. Press **ENTER**. Press **STOP** to return to **IdLE**.

Temperature Deviation (TEDE)

Adjust Temperature Sensitivity of Error Codes

The ideal temperature of a firing, at any given time, is called the set point. During a ramp, the set point changes at the rate you programmed. During a hold, the set point remains steady. The Sentry shows error messages when it can’t maintain the set point. The cushion, or leeway, allowed before an error message flashes is called Temperature Deviation. When the temperature is off by more than the Temperature Deviation setting, the alarm sounds. Temperature Deviation affects these error messages (see page 22):

- FTH** Fail to Heat
- FTC** Fail to Cool
- HTDE** High Temperature Deviation
- LTDE** Low Temperature Deviation

To turn these error codes off, enter a Temperature Deviation of 0.

CAUTION: The High Temperature Deviation (HTDE) alarm shuts off the kiln to prevent an overfire. Entering a temperature deviation of 0 shuts off this important alarm! Programming a firing at FULL rate (1799°F/999°C or higher rate) will also shut off the deviation alarms for that firing.

- 1 From **IdLE**, press **OPTIONS** repeatedly until **TEDE** appears.
- 2 Press **ENTER**. Change the deviation temperature. Press **ENTER**. Press **STOP** to return to **IdLE**.

Example: The Fail to Heat code **FTH** appears during firing, because the kiln could not heat as fast as programmed. The Temperature Deviation **TEDE** is 60°F. The Fail to Heat code appeared when the temperature was 60°F below the set point.

Maximum Temperature (SFTY)

View the Kiln’s Maximum Operating Temperature

From **IdLE**, press **OPTIONS** repeatedly until **SFTY** appears. Press **ENTER**. The temperature displayed is the maximum operating temperature programmed in the Sentry for your kiln. It can be altered only at the factory. Press **ENTER**. Press **STOP** to return to **IdLE**.

Electronics Temperature (ELEC)

Check the Circuit Board Temperature

High temperatures in the switch box can damage the controller circuit board, which is rated for 158°F/70°C maximum operating temperature. If necessary, exhaust hot air from the room to lower board temperature. When firing several kilns, position them at least three feet apart to allow adequate air circulation.

From **IdLE** or while firing, press **OPTIONS** repeatedly until **ELEC** appears. Press **ENTER**. The temperature of the circuit board will appear. Press **ENTER**. Press **STOP** to return to **IdLE**.

Program Lock (LOCK)

Make a Program Tamper-Proof

With Program Lock activated, a stored program cannot be altered or removed from memory. Use Program Lock for repeat firings that you don’t want to inadvertently change.

Note: Program Lock does not save a Delay setting. While a program is locked, you can enter a new Delay.

- 1 From **IdLE**, press **OPTIONS** repeatedly until **LOCK** appears.
- 2 Press **ENTER**. **LO** (locked) or **UN** (unlocked) will appear.
- 3 To change the setting, press **DELAY** 3 times.
- 4 Press **ENTER**. Press **STOP** to return to **IdLE**.

Configuration Code (CFG)

Information for Technicians

From **IdLE**, press **OPTIONS** repeatedly until **CFG** appears. Press **ENTER**. The factory configuration code will appear. Press **ENTER**. Press **STOP** to return to **IdLE**. The configuration code can be changed only at the factory.

Software Version (SOFT)

Information for Technicians

From **IdLE**, press **OPTIONS** repeatedly until **SOFT** appears. Press **ENTER**. The software version will appear. Press **ENTER**. Press **STOP** to return to **IdLE**. The software version can be changed only at the factory.

Element Test (TEST)

Test the Heating Elements and Relays

This test is useful when measuring the wall receptacle voltage under load, and amperage with an ammeter. On a multiple zone kiln, the test helps determine if the relays and thermocouples are wired to the correct zones. If you test thermocouples with a lighter or other heat source, use the Test option.

Single Zone Kiln

- 1 From **IdLE**, press **OPTIONS** repeatedly until **TEST** appears.
- 2 Press **ENTER**. **POWR** will appear, alternating with kiln temperature. The elements will turn on for 2 minutes. Press any key to abort the test.

Multiple Zone Kiln

- 1 From **IdLE**, press **OPTIONS** repeatedly until **TEST** appears.
- 2 Press **ENTER**. **TOP** will appear, alternating with the temperature of the top zone. The elements will turn on for 2 minutes. Then **MID** will appear, with temperature for the middle zone, and **BOT** with temperature for the bottom zone. (A 2 zone kiln shows **TOP** and **BOT** displays only.)
- 3 During the 2 minute test, press any key to end a zone test. The controller will then begin to test the next zone.

AOP Outlet

After the above tests, kilns equipped with the AOP outlet will display **J3-3** for 2 minutes to test power to the AOP outlet.

Reset (RST)

Reset the Controller to Most Factory Defaults: Perform Only When Requested by a Technician

Reset does the following:

- Selects Type-S thermocouple
- Selects °F
- Erases Cone offsets
- Erases Thermocouple offset
- Erases user programs in Ramp-Hold

CAUTION: If your kiln uses a Type-K thermocouple, the Sentry will underfire after a reset! Use the Thermocouple Option (page 19) to select Type-K again.

- 1 From **IdLE**, press **OPTIONS** repeatedly until **RST** appears.
- 2 Press **ENTER**. Use the **1** or **2** key to select **NO** or **YES**.
- 3 After selecting one of the above, press **ENTER**. Press **STOP** to return to **IdLE**.

Multiple Zone Options

These options appear only on multiple zone kilns.

Zone Temperature Difference (DIFF)

View Maximum Temperature Spread

For a 2 zone kiln, this option shows temperature difference between the zones. For a 3 zone kiln, it shows the highest temperature difference between any two zones. If the temperature shown is larger than expected, go to option T 123 to view the temperature of each zone.

- 1 Press **OPTIONS** repeatedly until **DIFF** appears. Press **ENTER**.
- 3 The maximum difference in temperature between any zones displays. (Example: **-003**.)

Two Zone Kilns: Adjust Heat in Center Section (CAJ)

The Center Adjust option appears only on 2 zone kilns that contain 3 relays and 3 banks of elements. It does not appear on 2 zone kilns with 2 relays, or on 3 zone. The Center Adjust acts as an infinite control switch that adjusts heat to the center section of the kiln. A number will display. 100 is the factory default, meaning 100% heat. You can change the setting from 0 to 200. The higher the number, the more the heat in the center section.

- 1 From **IdLE**, press **OPTIONS** repeatedly until **CAJ** appears.
- 2 Press **ENTER**. Use any number key to change the number that appears.
- 3 Press **ENTER**. Press **STOP** to return to **IdLE**.

Zone Temperatures (T123)

View Temperature of Each Zone

- 1 Press **OPTIONS** repeatedly until **T123** appears. Press **ENTER**.
- 3 The temperature for each zone will display one after the other, cycling for one minute. Then normal temperature display will return. For example:
 - Top zone: **TC 1** **1250**
 - Middle zone: **TC 2** **1251**
 - Bottom zone: **TC 3** **1249**



Chapter 7 Error Messages

- Error messages are accompanied by an alarm.
- Non-interrupting messages do not stop the firing. Terminating error messages do.
- FTC, FTH, LTdE, and HTdE error messages are based upon the setting in the Temperature Deviation (TEdE) option. See page 20.

For detailed diagnostics and maintenance, see “Sentry Trouble Shooter,” a separate publication.

Non-Interrupting Error Messages

Press **ENTER** to silence the alarm. (Do not press stop to silence the alarm.) The error message will remain but the kiln will continue firing.

FTC / Failed to Cool

- During a cooling ramp, the kiln cannot cool as quickly as programmed. The temperature is above the deviation setting. (See Temperature Deviation, page 20.)

Program a slower cooling rate.

FTH / Failed to Heat

- During a heating ramp, the kiln cannot heat as quickly as programmed. The temperature is below the deviation setting. (See Temperature Deviation, page 20.)

Check for worn or burned out elements, defective relays, low voltage and defective thermocouple. Program a slower rate.

LTdE / Low Temperature Deviation

- During a ramp or a hold, the temperature is below the deviation setting.

Check for worn or burned out elements, defective relays, low voltage and defective thermocouple.

PF / Power Failure

PF alternating with normal display means the power failed during firing. After power was restored, the firing resumed.

Terminating Error Messages

BAdP / Bad Programming

This message appears when a Ramp-Hold firing has been programmed with 0 rate in the first segment.

ETH / Electronics Too Hot

- The circuit board temperature is above 185°F/85°C.

Open windows and use a fan to circulate air in the room before firing the kiln or furnace. If you have more than one kiln in the room, place them farther apart. Never allow the firing room temperature to exceed 110°F/43°C. (Measure room temperature three feet away from the kiln.)

FAIL / Thermocouple Failure

- Defective Thermocouple
- Disconnected Thermocouple Lead Wires
- Defective Board
- Electrical Noise

FTL / Firing Too Long

- The temperature rise is less than 27°F/15°C per hour and the firing time is four hours longer than the current segment was programmed to fire.

Check for worn or burned out elements, defective relays, low voltage and defective thermocouple.

HTdE / High Temperature Deviation

- During a ramp or a hold, the temperature is above the deviation setting.

Check for a stuck relay.

PF 2 / Power Failure

- The power failed. The kiln temperature was below 212°F/100°C when the power came back on.

The kiln will not resume firing.

PF 3 / Power Failure

This message appears when two conditions are met:

- 1 The power failed during the final segment of a Cone-Fire firing. Or, the power failed during the final segment of a Ramp-Hold firing that included a 108°F/60°C rate in the final segment.
- 2 The temperature dropped 72°F/40°C while the power was off.

The kiln will not resume firing.

How the Sentry Handles Power Failures

The Sentry handles a power failure in two ways:

- 1 After a brief power failure, the controller continues firing as before. It shows a normal temperature display alternating with **PF**.
- 2 After an extended power failure, **PF2** or **PF 3** will appear. The kiln will NOT resume firing.

The controller will resume the firing after a brief power failure provided these conditions are met:

- The temperature must be above 212°F/100°C when the power comes back on.
- A Ramp-Hold programmed with a rate of 108°F/60°C in the final segment: if power failed in the final segment, the temperature dropped less than 72°F/40°C.
- Cone-Fire: if power failed in the final segment, the temperature dropped less than 72°F/40°C.

When the Sentry aborts a firing after a power failure, the display will show the following:

- **PF 2** or **PF 3**
- Total firing time before power failed
- Temperature at the time of power failure
- Current kiln temperature

To resume firing, press **ENTER**. The kiln will begin firing again from its present temperature. For example, the kiln reached 1000°F/538°C when power failed. The temperature is 800°F/426°C when you turn the kiln back on. Firing will resume from 800°F/426°C. You need not cool the kiln to room temperature before starting a ceramic firing over unless you decide to use new witness cones.

When you resume firing by pressing **ENTER**, the controller begins firing in the first segment with a temperature higher than the current kiln temperature. However, if the power failed during a ramping down (cooling) segment, the controller will resume firing from the same cooling segment.

Using Ceramic Shelf Cones After an Extended Power Failure

- **The firing was interrupted more than 100°F/56°C from the terminal temperature:** Fire the ware again. It is okay to use the same partially fired witness cones, even if they cooled back down to room temperature. So long as the cones did not heat to within 100°F/56°C of maturity, they can be used again.
- **The firing was interrupted less than 100°F/56°C from the terminal temperature:** Fire the ware again. If the kiln shuts off within 100°F/55°C of maturity, and the temperature drops 50°F/28°C or more after the kiln shuts off, do not depend on the witness cones. Once they cool 50°F/28°C after they have been heated to within 100°F/55°C of maturity, they will not bend properly. This is because they form a hard shell.

PLOG Error Codes

A PLOG error code means that the controller failed a self-diagnostic test. A chattering, noisy relay, low voltage, and the wrong relay type can cause a PLOG error. The controller will not operate while a PLOG message appears.

PLOG 3 / Memory Corruption

Resets the Sentry to factory default settings.

PLOG 4 / Configuration Corruption

Return the Sentry to the factory after a PLOG 4 code.

PLOG 5 / Firmware Problem

PLOG 6 / Software Problem

PLOG 7, 8, 9 / Non-Volatile Memory Problem

PLOG 10 / Program Storage Problem

PLOG 11 / Bad Thermocouple Signal for 60 seconds

Clearing a PLOG 11 Error Code

PLOG 11 indicates that a thermocouple is about to fail or that electrical noise is affecting the thermocouple.

- Try moving the thermocouple lead wires away from nearby electrical wires and relays.
- Make sure the bare part of the leads extending from the thermocouple are not touching the kiln case.
- Replacing the thermocouple usually clears the PLOG 11 code.

Clearing the Other PLOG Error Codes

- Clear the PLOG error code by pressing **ENTER**.
- If pressing **ENTER** does not clear a PLOG error, turn off power to the kiln for 10 seconds. Repeat if necessary. After a PLOG error clears, it is okay to fire the kiln again.

TCdE / Uneven Multiple Zone Temperatures

On a multiple zone kiln, TCdE usually means the thermocouples and elements are improperly wired. A thermocouple is turning on the elements to the wrong zone. For instance, if the top thermocouple turns on the bottom elements, the kiln will fire out of balance. When zones are out of balance by 140°F/60°C, TCdE will appear in the display.

Visually compare the wiring of the thermocouples, relays and elements of your kiln to the kiln's wiring diagram. Also, use the Element Test option shown on page 21.

TCR / Thermocouple Leads Reversed

Check that the thermocouple lead wires are connected to the correct terminals. See your wiring diagram.

Appendix A: Display Messages

Message	Definition	Page Reference	Message	Definition	Page Reference
AbRT	Abort	6	F 20	Fast Speed	17
	The firing was stopped.			Cone-Fire fast speed shows in Program Review as F 20. This is also how Fast Speed is listed in the SPd Speed option.	
ALAR	Alarm	6, 10, 13 - 15, 20, 22	FAIL	Thermocouple Failed 22	
	ALAR appears either when you are entering an alarm temperature or when the alarm is sounding during a firing. To stop an alarm, press any key except STOP. If the alarm goes off when you first begin firing, it is because it was set for a lower temperature than the present temperature.			The thermocouple failed. This can be due to a broken thermocouple, loose thermocouple connection on the back of the Sentry, disconnected thermocouple wire, or a defective controller.	
AOP	Auxiliary Output	10, 11, 13, 14, 18, 20	FAN	Vent Fan	11, 18, 20
	The AOP option is for kilns equipped with a special-order kiln switch box receptacle called the Auxiliary Output.			The Fan option, accessed through the OPTIONS key, is for kilns equipped with a special-order kiln switch box receptacle called the Auxiliary Output.	
bAdP	Bad Programming	22	FAST	Fast Speed	10
	This message appears when a Ramp-Hold firing has been programmed with 0 rate in the first segment.			In Cone-Fire programming, if you press ENTER when FAST appears, the kiln will program to fire at fast speed.	
CAdJ	Center Adjust	16	FN 1	Fan	13, 14
	For two zone kilns only. This option adjusts the center section of the kiln.			If your kiln has the optional AOP outlet (for a kiln vent), the FN prompt will appear for each segment during Ramp-Hold programming. It is asking if you want the vent on or off for that segment.	
CFG	Configuration Code	21	FTC	Failed to Cool	22
	This is an option that shows the factory configuration code for your Sentry. This is for technicians who call the factory for support.			This error message means the kiln cannot cool as fast as the cooling that you programmed.	
CHG-	Change °F / °C	19	FTH	Failed to Heat	22
	Choose between operation in degrees F or degrees C.			The kiln cannot heat as fast as you programmed.	
CONE	Cone-Fire	10	FTL	Firing Too Long	22
	The Sentry is ready for you to enter a cone number.			The temperature rise is less than 27°F/15°C per hour and the firing time is four hours longer than the current segment was programmed.	
COOL	Slow Cooling	10	FULL	Full Speed	13
	In Cone-Fire programming, Slow Cooling is shown as COOL. To program a slow cooling, enter the cooling rate in degrees per hour. Leave the setting at 0 if you do not want a slow cooling.			The rate, or temperature change per hour, is maximum.	
CPLT	Completed Firing	5, 10, 13	Hd 1	Temperature Hold	13, 14
	This means the firing completed as programmed.			When this message appears during Ramp-Hold programming, it is asking you if you want to hold, or maintain, the target temperature of that segment. If so, enter the length of hold time in hours and minutes (i.e. 1 hour 20 minutes = 01.20). The number after Hd is the segment number. Each segment in a Ramp-Hold firing is numbered, starting with 1.	
DELA	Delay	6, 10, 13	HOLD	Temperature Hold	10
	DELA is a timer that starts the kiln later. Delay time appears in hours and minutes.			When this message appears during Cone-Fire programming, it is asking you if you want to hold, or maintain, the cone temperature at the end of the firing. If so, enter the length of hold time in hours and minutes (i.e. 1 hour 20 minutes = 01.20). When HOLD appears in program review, it is showing how much hold time has been entered.	
°F 1 or °C 1	Target Temperature	13	HtdE	High Temperature Deviation	22
	This prompt, which appears in Ramp-Hold programming, is asking for a target temperature. The number is to remind you which segment the temperature is for.			The temperature is above the Temperature Deviation setting in the TEDE option.	
DIFF	Temperature Difference	16, 21	ID	Computer ID	20
	This option shows the maximum temperature spread between zones in a multiple zone kiln.			The ID option is for connecting the Sentry to a personal computer.	
ELEC	Electronics Temperature	20			
	The Sentry circuit board is rated for operation at temperatures up to 158°F/70°C. When the circuit board gets hotter, the Sentry shuts off. The ELEC option tells you how hot the circuit board is.				
ETH	Electronics Too Hot	22			
	The Sentry circuit board is too hot, so the kiln was shut off.				

Message	Definition	Page Reference
IdLE	Ready to Begin	5
	The Sentry must display the IdLE message before you can begin firing or programming.	
LId	Lid is Open	5
	When LId appears, the kiln is equipped with a lid safety switch, and the lid (or door) is open during firing. Or a two-pin connector on the back of the board is missing.	
LOCK	Program Lock	20
	With this option activated, a stored program cannot be altered or removed from memory.	
LTdE	Low Temperature Deviation	22
	This message appears when the kiln is below the Temperature Deviation setting in the TEDE option.	
OFST	Cone Offset	17
	Adjust a Cone-Fire program to bend the matching witness cone on the kiln shelf.	
PF 2	Power Failure	22, 23
	The power failed. When power came back on, the temperature was below 212°F/100°C.	
PF 3	Power Failure	22, 23
	The power failed near the end of a firing.	
PF	Power Failure	22, 23
	There was a power failure during firing. The kiln continued firing after power came back on.	
PLOG	Diagnostic Test Failure	23
PRHT	Pre-Heat	9, 10
	In a Cone-Fire program, Pre-Heat heats the ware slowly to 200°F/93°C for the length of time you specify. Pre-Heat is designed to remove moisture safely from greenware.	
RA 1	Rate	13
	RA 1, RA 2, RA 3, etc., appears in Ramp-Hold programming, Program Review, and Present Status. When RA 1, 2, 3, etc. appear during programming, the controller is asking you for firing rate for each segment. Rate means how fast the firing progresses, in degrees of temperature per hour. Every segment must have a firing rate. The number after RA is the segment number. Each segment in a Ramp-Hold firing is numbered, starting with 1. Program Review shows firing rate after RA 1, 2, 3, etc. In Present Status, RA 1, 2, 3, etc. means the segment that the firing is in at that moment.	
RST	Reset	21
	The RST option erases cone and thermocouple offsets, selects °F operation, erases stored programs in Ramp-Hold, and selects Type-S thermocouple. Note that if you use Reset, and your kiln is equipped with a Type-K thermocouple, you must use the TC option to select Type-K. (Reset selects Type-S as a safety precaution. If you had a Type-S thermocouple and Reset selected Type-K, your kiln would overfire. On the other hand, if you have a Type-K thermocouple, Type-S selected would underfire your kiln. The type K thermocouple is standard on most kilns.)	
S 20	Slow Speed	17
	Cone-Fire slow speed shows in Program Review as S 20. This is also how slow speed is listed in the SPd Speed option.	
SFTY	Safety	20
	This is the maximum temperature the Sentry is programmed for your kiln. It can be altered only at the factory.	

Message	Definition	Page Reference
SKIP	Skip Segment	7
	If you press the Skip Segment key during a firing, SKIP will appear. If you press the key again, the firing will skip to the next segment. In Cone-Fire, Skip Segment takes you only out of Pre-Heat or Hold.	
SLOW	Slow Speed	10
	In Cone-Fire programming, if you press ENTER when SLOW appears, the kiln will program to fire at slow speed.	
SOFT	Software Version	21
	This option gives the version of software loaded into your Sentry.	
SPd	Speed	10, 17
	The SPd message appears during Cone-Fire programming and in Options. In the SPd option, accessed through the option key, change the speed of a Cone-Fire program beyond the standard fast, medium or slow. While programming a firing for Cone-Fire, choose slow, medium or fast speed at the SPd prompt.	
STd	Standard Speed	17
	Cone-Fire medium speed appears in the Sentry as STd, or Standard. This is because medium speed is the standard firing program used in Cone-Fire. Fast and Slow speeds alter the standard firing program.	
STRT	Firing Started	10, 13
	This appears when firing begins. Do not be concerned if it takes a moment for the relays to turn on. The Sentry is processing data.	
T123	Zone Temperatures	21
	This option shows temperatures in each zone.	
TC	Thermocouple Type	19
	Choose between types K, S, or R thermocouple. It is important to select the correct type, or the controller will not read temperature accurately.	
TcdE	Uneven Temperature	23
	This is an error message for multiple zone kilns. It means the temperatures of the zones are out of balance. This is usually caused by a miswired kiln or by a defective relay.	
TCOS	Thermocouple Offset	18
	Calibrate the controller's temperature. This compensates for temperature drift, or aging, of a thermocouple.	
TCR	Thermocouple Reversed	23
	The thermocouple wires are reversed.	
TEDE	Temperature Deviation	20
	The Sentry includes error messages to warn you that the kiln is not maintaining the programmed temperature. The sensitivity of the error messages is based on a temperature entered in the TEDE option.	
TEST	Element Test	21
	This option is for testing the elements and thermocouples. If you test a thermocouple with a lighter, the temperature display responds faster during Test than during IdLE display.	
USER	User Program	13, 14
	In Ramp-Hold programming, the USER prompt is asking you where you want to place the program in memory. The Sentry has four spaces in memory: 1, 2, 3, 4. Keep a record, on paper, of the programs in memory.	

Appendix B: Preset Standard Cone-Fire Schedules - °F

These are the firing schedules programmed in Cone-Fire mode. To customize a schedule, write down your changes. Then load your new schedule into Ramp-Hold.

Low Fire Cones °F

Cone	Segment 1		Segment 2	
	Rate 1	Temp. 1	Rate 2	Temp. 2
022	396	979	108	1087
021	396	1004	108	1112
020	396	1051	108	1159
019	396	1144	108	1252
018	396	1211	108	1319
017	396	1252	108	1360
016	396	1314	108	1422
015	396	1348	108	1456
014	396	1377	108	1485
013	396	1431	108	1539
012	396	1474	108	1582
011	396	1499	108	1607

Medium Fire Cones °F

Cone	Segment 1		Segment 2		Segment 3		Segment 4	
	Rate 1	Temp. 1	Rate 2	Temp. 2	Rate 3	Temp. 3	Rate 4	Temp. 4
010	324	1022	153	1112	180	1549	108	1657
09	324	1022	153	1112	180	1580	108	1688
08	324	1022	153	1112	180	1620	108	1728
07	324	1022	153	1112	180	1681	108	1789
06	324	1022	153	1112	180	1720	108	1828
05	324	1022	153	1112	180	1780	108	1888
04	324	1022	153	1112	180	1837	108	1945
03	324	1022	153	1112	180	1879	108	1987
02	324	1022	153	1112	180	1908	108	2016
01	324	1022	153	1112	180	1938	108	2046

High Fire Cones °F

Cone	Segment 1		Segment 2		Segment 3		Segment 4	
	Rate 1	Temp. 1	Rate 2	Temp. 2	Rate 3	Temp. 3	Rate 4	Temp. 4
1	324	1022	153	1112	162	1863	108	2079
2	324	1022	153	1112	162	1872	108	2088
3	324	1022	153	1112	162	1890	108	2106
4	324	1022	153	1112	162	1908	108	2124
5	324	1022	153	1112	162	1951	108	2167
6	324	1022	153	1112	162	2016	108	2232
7	324	1022	153	1112	162	2046	108	2262
8	324	1022	153	1112	162	2064	108	2280
9	324	1022	153	1112	162	2084	108	2300
10	324	1022	153	1112	162	2129	108	2345

Appendix B: Preset Standard Cone-Fire Schedules - °C

These are the firing schedules programmed in Cone-Fire mode. To customize a schedule, write down your changes. Then load your new schedule into Ramp-Hold.

Low Fire Cones °C

Cone	Segment 1		Segment 2	
	Rate 1	Temp. 1	Rate 2	Temp. 2
022	220	526	60	586
021	220	540	60	600
020	220	566	60	626
019	220	618	60	678
018	220	655	60	715
017	220	678	60	738
016	220	712	60	772
015	220	731	60	791
014	220	747	60	807
013	220	777	60	837
012	220	801	60	861
011	220	815	60	875

Medium Fire Cones °C

Cone	Segment 1		Segment 2		Segment 3		Segment 4	
	Rate 1	Temp. 1	Rate 2	Temp. 2	Rate 3	Temp. 3	Rate 4	Temp. 4
010	180	550	85	600	100	843	60	903
09	180	550	85	600	100	860	60	920
08	180	550	85	600	100	882	60	942
07	180	550	85	600	100	916	60	976
06	180	550	85	600	100	938	60	998
05	180	550	85	600	100	971	60	1031
04	180	550	85	600	100	1003	60	1063
03	180	550	85	600	100	1026	60	1086
02	180	550	85	600	100	1042	60	1102
01	180	550	85	600	100	1059	60	1119

High Fire Cones °C

Cone	Segment 1		Segment 2		Segment 3		Segment 4	
	Rate 1	Temp. 1	Rate 2	Temp. 2	Rate 3	Temp. 3	Rate 4	Temp. 4
1	180	550	100	600	90	1017	60	1137
2	180	550	100	600	90	1022	60	1142
3	180	550	100	600	90	1032	60	1152
4	180	550	100	600	90	1042	60	1162
5	180	550	100	600	90	1066	60	1186
6	180	550	100	600	90	1102	60	1222
7	180	550	100	600	90	1119	60	1239
8	180	550	100	600	90	1129	60	1249
9	180	550	100	600	90	1140	60	1260
10	180	550	100	600	90	1165	60	1285

Appendix C: Upgrading Instructions

Upgrading the DTC 100, 600, 800 & 1000 to the Sentry

- 1 Unplug the kiln or disconnect the power. Remove the 4 screws holding the controller faceplate to the switch box. Gently remove the old controller.
- 2 Disconnect the wires from the old controller.

- 3 If your kiln is top-loading and originally came with a DTC 100 or 600, the heat shield inside the switch box may need to be moved to give more clearance for the new Sentry controller. Measure the space between the heat shield and the front of the box. If the space is less than 1 3/4", remove the screws that hold the bottom of the heat shield. These screws are on the sides near the louvers. Drill new holes in either the box or the heat shield. Move the bottom of the heat shield back and fasten screws in the new holes.



- 4 Thread the Sentry wiring harness into the switch box by inserting it in the opening where the controller goes. Let the end with the plugs hang out of the box.



- 5 Remove the switch box from the kiln by removing the screws holding the box to the kiln.



- 6 The red wire from the old controller connects to the relays.

The extra wires tied to the harness are for multiple zone kilns and the optional AOP electrical outlet.

The red wire in the Sentry wiring harness goes to the same relay terminal. (See diagram, facing page.) You will notice that the red Sentry wire has 3 push-on connectors with jumper wires. If your kiln has 3 relays, you will use all 3 push-on connectors, 1 for each relay. If you have 2 relays, cut off the last terminal and jumper wire. If your kiln has 1 relay, cut off two push-on connectors. Cut the wire close to the other terminal (see next photo).

CAUTION: Cut off the extra terminal(s) and jumper wire(s) unless they are attached to relays. Unconnected wires that touch a grounded object can damage your controller!

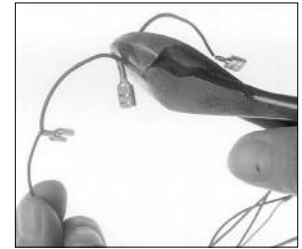

- 7 Attach the red wire terminal(s) to the relay(s). Follow steps 6 and 7 for the black wire, which also goes to the relays.
- 8 Note how the white, orange, and blue wires of the old controller are connected to the transformer. Removing and replacing one wire at a time, connect the Sentry white, orange, and blue wires to the transformer the same way.
- 9 Find the green grounding screw. Securely fasten the green wire under the nut of grounding screw.
- 10 Remove the old wiring harness from the switch box. With the thermocouple wires and the Sentry connection plugs hanging out of the front of the switch box, move the box into place on the kiln. Arrange the wires so that when the switch box is fastened to the kiln, the wires and wire nuts will not touch an element connector or the kiln case. Install the screws that hold the switch box to the kiln.

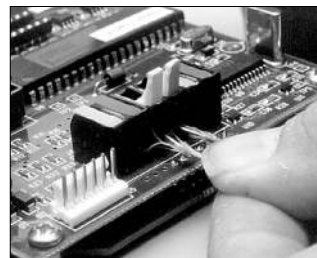

Lever type connectors: if the wire is too thick, it will break the lever. Do not force the lever downward.

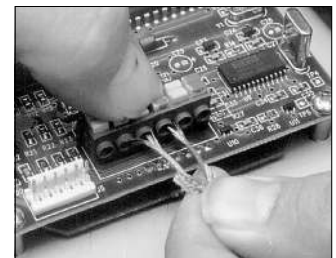

The button-type thermocouple connector: press down, then insert wires.

- 11 Straighten the ends of the thermocouple wires. Attach them to the thermocouple terminals on the bottom of the Sentry. (Use the center connectors if your kiln has only one thermocouple.) Make sure the thermocouple wires are tight.

- 11 Attach the two plugs to the back of the Sentry controller. Carefully insert the Sentry into the controller opening on the switch box. Install the 4 corner screws.

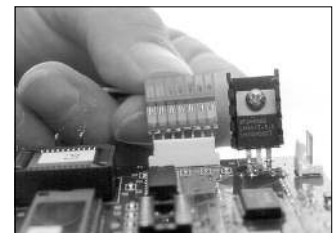

Inserting the plugs on the back of the Sentry.

How to Wire the Sentry

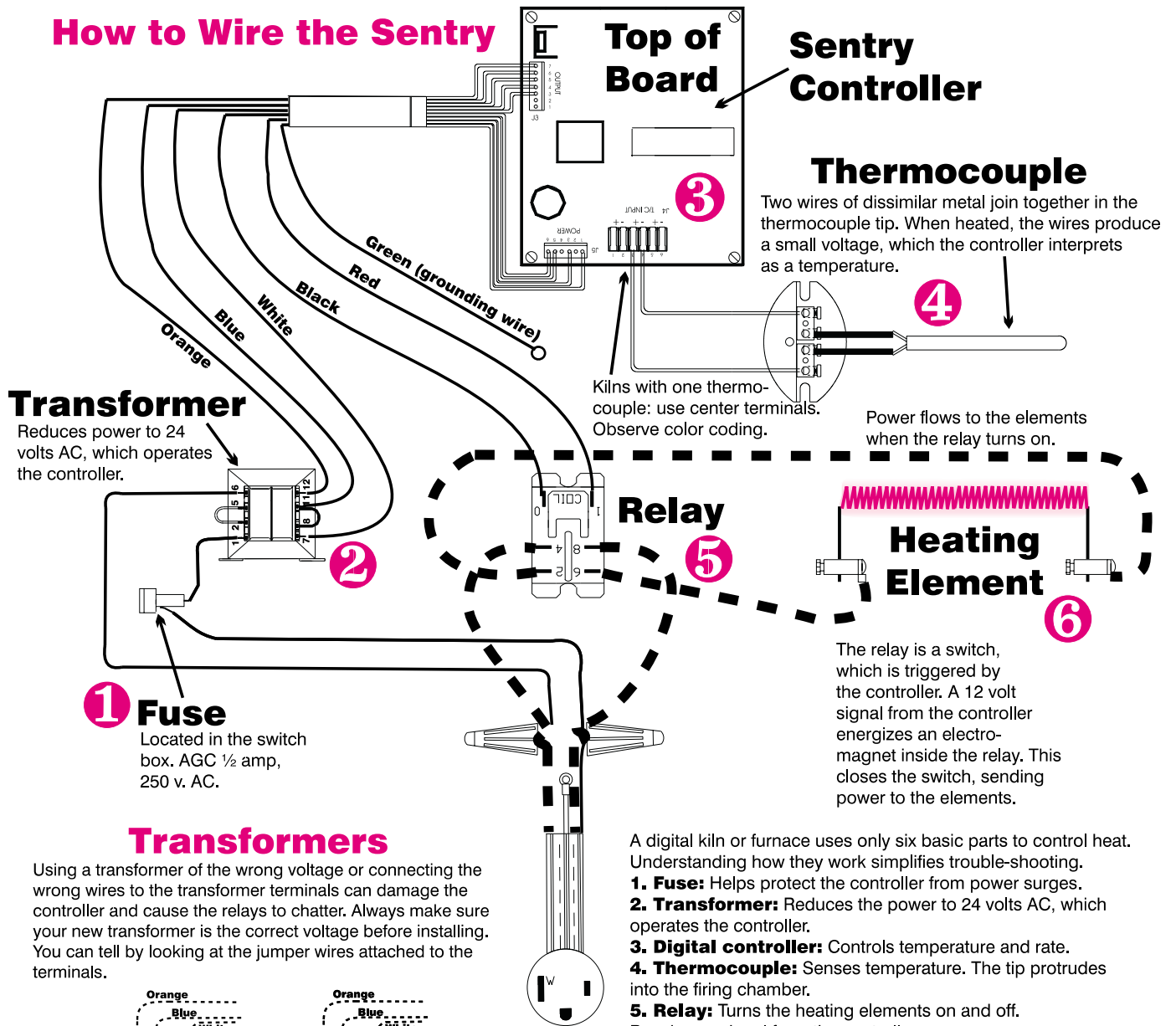

Transformers

Using a transformer of the wrong voltage or connecting the wrong wires to the transformer terminals can damage the controller and cause the relays to chatter. Always make sure your new transformer is the correct voltage before installing. You can tell by looking at the jumper wires attached to the terminals.

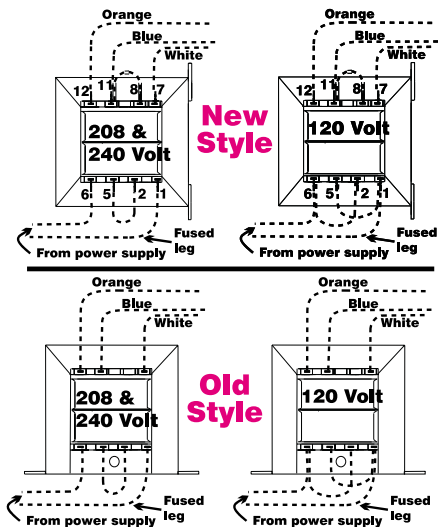

A digital kiln or furnace uses only six basic parts to control heat. Understanding how they work simplifies trouble-shooting.

- 1. Fuse:** Helps protect the controller from power surges.
- 2. Transformer:** Reduces the power to 24 volts AC, which operates the controller.
- 3. Digital controller:** Controls temperature and rate.
- 4. Thermocouple:** Senses temperature. The tip protrudes into the firing chamber.
- 5. Relay:** Turns the heating elements on and off. Receives a signal from the controller.
- 6. Heating elements**

Wiring Single & Multiple Relays

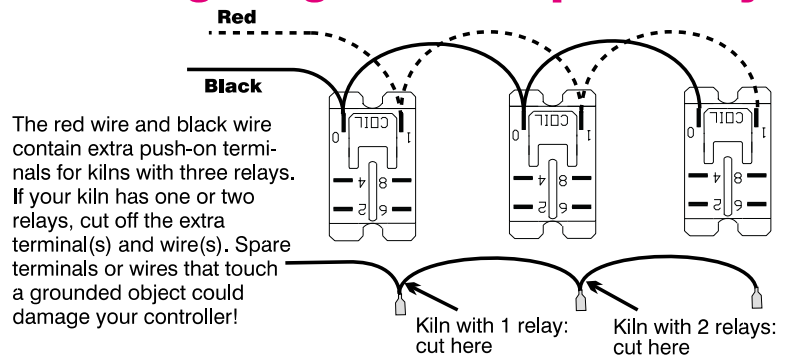

Appendix D: Temperature Equivalents For Orton Self-Supporting Pyrometric Cones

°F

Cone Number	Self-Supporting Cones			Pre-Fire Color
	Heated at: 27° F Per Hour*	108° F Per Hour*	270° F Per Hour*	
022	—	1087	1094	Green
021	—	1112	1143	Fuschia
020	—	1159	1180	Orange
019	1213	1252	1283	Yellow
018	1267	1319	1353	White
017	1301	1360	1405	Pink
016	1368	1422	1465	Light Blue
015	1382	1456	1504	Violet
014	1395	1485	1540	Gray
013	1485	1539	1582	Green
012	1549	1582	1620	Fuschia
011	1575	1607	1641	Orange
010	1636	1657	1679	Dark Red
09	1665	1688	1706	Dark Red
08	1692	1728	1753	Dark Red
07	1764	1789	1809	Dark Red
06	1798	1828	1855	Dark Red
05 1/2	1839	1859	1877	Dark Red
05	1870	1888	1911	Dark Red
04	1915	1945	1971	Dark Red
03	1960	1987	2019	Dark Red
02	1972	2016	2052	Dark Red
01	1999	2046	2080	Dark Red
1	2028	2079	2109	Dark Red
2	2034	2088	2127	Dark Red
3	2039	2106	2138	Dark Red
4	2086	2124	2161	Gray
5	2118	2167	2205	Green
5 1/2	2133	2197	2237	White
6	2165	2232	2269	Fuchsia
7	2194	2262	2295	Orange
8	2212	2280	2320	Yellow
9	2235	2300	2336	White
10	2284	2345	2381	Pink

*Rate of temperature increase during last 90 - 120 minutes of firing. Tables by courtesy of the Edward Orton, Jr. Ceramic Foundation.

°C

Cone Number	Self-Supporting Cones			Pre-Fire Color
	Heated at: 15° C Per Hour*	60° C Per Hour*	150° C Per Hour*	
022	—	586	590	Green
021	—	600	617	Fuschia
020	—	626	638	Orange
019	656	678	695	Yellow
018	686	715	734	White
017	705	738	763	Pink
016	742	772	796	Light Blue
015	750	791	818	Violet
014	757	807	838	Gray
013	807	837	861	Green
012	843	861	882	Fuschia
011	857	875	894	Orange
010	891	903	915	Dark Red
09	907	920	930	Dark Red
08	922	942	956	Dark Red
07	962	976	987	Dark Red
06	981	998	1013	Dark Red
05 1/2	1004	1015	1025	Dark Red
05	1021	1031	1044	Dark Red
04	1046	1063	1077	Dark Red
03	1071	1086	1104	Dark Red
02	1078	1102	1122	Dark Red
01	1093	1119	1138	Dark Red
1	1109	1137	1154	Dark Red
2	1112	1142	1164	Dark Red
3	1115	1152	1170	Dark Red
4	1141	1162	1183	Gray
5	1159	1186	1207	Green
5 1/2	1167	1203	1225	White
6	1185	1222	1243	Fuchsia
7	1201	1239	1257	Orange
8	1211	1249	1271	Yellow
9	1224	1260	1280	White
10	1251	1285	1305	Pink

*Rate of temperature increase during last 90 - 120 minutes of firing. Tables by courtesy of the Edward Orton, Jr. Ceramic Foundation.

Appendix E:

Sentry Ramp-Hold Shorthand Instructions

After you press the keys in the left column, the message to the right will appear.

KEYS TO PRESS	DISPLAY	COMMENTS
<u>PROGRAM AND FIRE THE KILN.</u>		
Apply power to kiln	IdLE	Press Enter if IdLE does not appear.
4	USER	Enter program number.
1, 2, 3, or 4	1	Program number appears.
ENTER	RA 1	Enter rate of segment 1.
Rate	0200	Rate appears.
ENTER	°F 1	Enter temperature of segment 1.
Temperature	2000	Temperature appears.
ENTER	Hd 1	Next, enter hold time.
Hold time (0 if none)	00.00	Hold time appears.
<u>Repeat for other segments. Enter rate of 0 for 1st segment not needed.</u>		
ENTER	IdLE	The kiln is ready to fire.
ENTER	STRT	Kiln is now firing.
<u>SELECT AND FIRE A STORED USER PROGRAM.</u>		
Apply power to kiln	IdLE	Press Enter if IdLE does not appear.
4	USER	Select a program number.
1, 2, 3, or 4	1	Displays the number you selected.
ENTER	RA 1	
STOP	IdLE	Selected program is ready to fire.
ENTER	STRT	
<u>Kiln is now firing. (Use Program Review by pressing 6.)</u>		

Appendix F:

Sentry Cone-Fire Shorthand Programming

After you press the key(s) in the left column, the message to the right will appear. Press **1** from **IdLE**. If the **1** key does not respond, your controller does not have Cone-Fire.

KEYS TO PRESS	DISPLAY	COMMENTS
Apply power to kiln	IdLE	Press Enter if IdLE doesn't appear.
1	CONE	Enter the cone number.
Cone # (i.e. 05)	05	
ENTER	SPd	Enter the firing speed.
1 (Fast), 2 (Med.), or 3 (Slow)	FAST	The firing speed appears.
ENTER	PRHT	Enter Pre-heat time.
Pre-Heat time (0 if none)	00.00	Pre-heat time appears.
ENTER	HOLD	Enter hold time.
Hold time (0 if none)	00.00	Hold time appears.
ENTER	COOL	Enter slow cooling rate.
Slow cooling rate (0 if none)	0000	Shows degrees per hour.
ENTER	IdLE	Kiln is ready to fire.
ENTER	STRT	Kiln is now firing. Press 6 for Program Review.

The Kiln is now firing to the cone you selected.